

MIE
and
my
News

MisuraEmme®





Nel segno di una sartorialità senza confini che definisce nuovi codici progettuali. Inedite laccature ed essenze sofisticate avvolgono le atmosfere su misura.

In the sign of a limitless bespoke appeal that defines new design codes. New lacquers and sophisticated essences dress the tailor-made atmospheres.

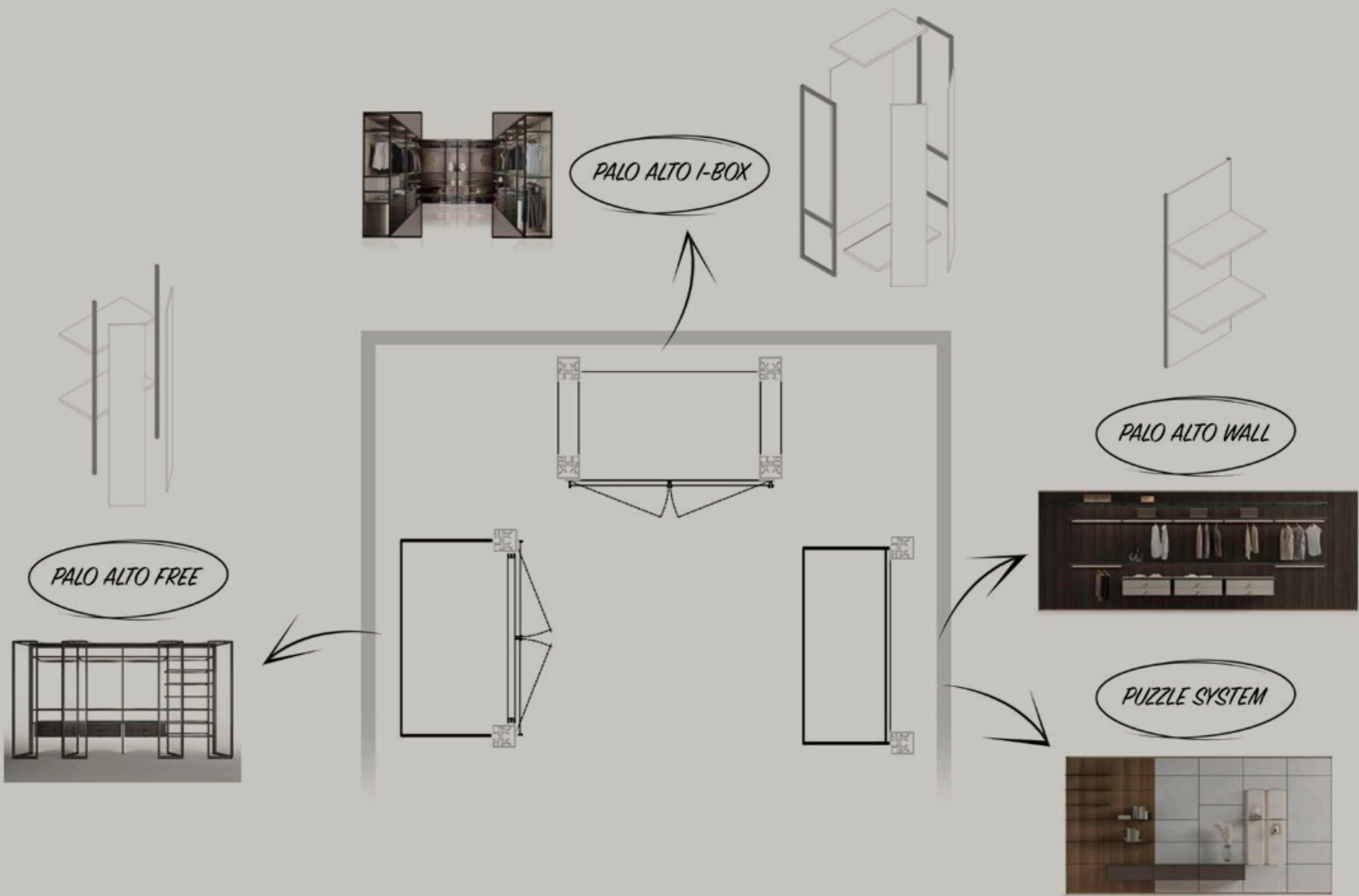

**INTERIOR
INSPIRATION,
NEW CONCEPT.**





On the previous pages, on the facing page and on the following pages: Boserie **Puzzle** system, paneling in Waves canaletto walnut finish and white cementino melamine, profiles and shelves in gunmetal painted aluminum. Teka elements in transparent glass, open container in sepia etched glass. **Eros** low sideboard, Calacatta Gold marble top, Black Oak essence structure, bronze painted metal base. **Argo** sofa with 45 ° inclined pentagonal Chaise Lounge, fabric upholstery. **Gemini Round** Coffee Table Essence Glossy Ebony. **Ermes** armchair leather upholstery and swivel base in satin stainless steel. **Moai** glossy lacquered coffee table.

Nelle pagine precedenti, nella pagina a fianco e in quelle successive: Sistema Boserie **Puzzle**, pannellatura in finitura Waves noce canaletto e melaminico cementino white, profili e mensole alluminio verniciato canna di fucile. Elementi teka in vetro trasparente, contenitore giorno in vetro acidato sepia. Madia bassa **Eros**, piano marmo Calacatta Oro, struttura essenza Rovere Nero, basamento metallo verniciato bronzo. Divano **Argo** con Chaise Lounge inclinata a 45° pentagonale, rivestimento tessuto. Tavolino **Gemini Round** Essenza Ebano lucido. Poltrona **Ermes** rivestimento pelle e base girevole Acciaio Inox satinato. Tavolino **Moai** laccato lucido.





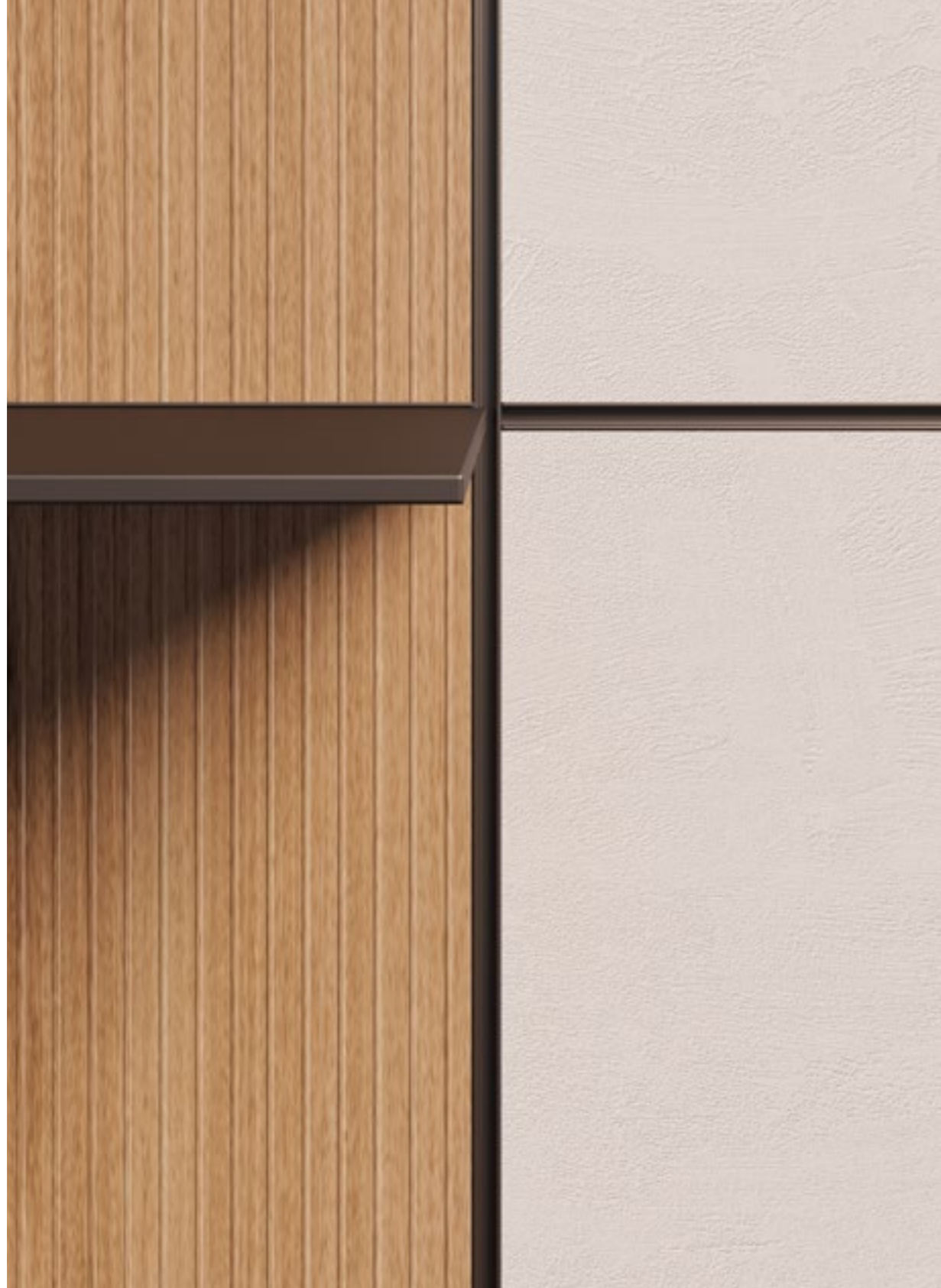

Opposite page: **Puzzle** boiserie system detail, paneling in Waves canaletto walnut finish and white cementino melamine, gunmetal painted aluminum profiles and shelves.

Nella pagina a fianco: Dettaglio sistema boiserie **Puzzle**, pannellatura in finitura Waves noce canaletto e melaminico cementino white, profili e mensole alluminio verniciato canna di fucile.



On the previous pages and on the side page: sofa **Argo** corner unit with Chaise Lounge shaped at 45° pentagonal, fabric cover. Small table **Rialto 3/4** top smoked glass and black painted metal base and antiqued brass. Small table **Gemini Round** in wood Ebony glossy. **Moai** side table polish lacquer color Petrolio. Armchair **Ermes** upholstery leather and swivel base Satin stainless steel.

Nelle pagine precedenti e nella pagina a fianco: divano ad angolo **Argo** con Chaise Lounge inclinata a 45° pentagonale, rivestimento tessuto. Tavolino **Rialto 3/4** piano vetro fumè e base metallo verniciato nero e Ottone anticato. Tavolino **Gemini Round** Essenza Ebano lucido. Tavolino **Moai** laccato lucido Petrolio. Poltrona **Ermes** rivestimento pelle e base girevole Acciaio Inox satinato.





On the side page: Detail from above of the pentagonal shaped at 45° Chaise Lounge of the **Argo** sofa, covered in fabric.

Nella pagina a fianco: Dettaglio dall'alto della Chaise Lounge inclinata a 45° pentagonale del divano **Argo**, rivestito in tessuto.

On the side page: detail optional headrest of the **Argo**
sofa quilted leather upholstery.

Nella pagina a fianco: dettaglio poggia testa opzionale
del divano **Argo** rivestimento pelle trapuntata.







Previous pages: Boserie **Puzzle** system, paneling in white cementino melamine finish, gunmetal painted aluminum profiles and shelves. Teka elements in transparent glass, open container in sepia etched glass.

Opposite page: Detail of teka element, in transparent glass with LED light.

Nelle pagine precedenti: Sistema Boserie **Puzzle**, pannellatura in finitura melaminico cementino white, profili e mensole alluminio verniciato canna di fucile. Elementi teka in vetro trasparente, contenitore giorno in vetro acidato sepia.

Nella pagina a fianco: Dettaglio elemento teka, in vetro trasparente con luce led.

In these pages: **Palo Alto I-Box** night system, **Tecno** doors finish melamine champagne. **Stiletto** small table with Calacatta gold marble top, metal stem painted white gesso color, base metal painted Antiqued brass. Sofa **Virgin Round** upholstery in leather Nabuck.

In queste pagine: sistema notte **Palo Alto I-Box**, ante **Tecno** champagne. Tavolino **Stiletto** con piano in marmo Calacatta oro, stelo metallo verniciato gesso, base metallo verniciato Ottone anticato. Divano **Virgin Round** rivestimento Nabuck.





On the side page: detail of the **Palo Alto I-Box** night system, interior equipment with smoked th.12 mm glass shelf, graphite metallic melamine suspended chest of drawers with **Flush** handle.

Nella pagina a fianco: dettaglio attrezzatura interna sistema notte **Palo Alto I-Box**, ripiano in vetro Fumè Sp.12 mm, cassettiera sospesa nobilitato metallizzato Graphite con maniglia **Flush**.





In the previous pages: **Millimetrica** night system, framed sides in Gun metal finish, Tecno-Marble backpanel, internal equipment in Graphite metallic melamine and eco-leather. **Palo Alto I-Box** night system, with **Narcisse** transparent glass coplanar doors, sides frame in aluminum finish Gun metal, backrests tecno-marble, internal equipment in melamine metallic Graphite and eco-leather. **Virgin** armchairs without armrests, leather upholstery. **Virgin** armchairs without armrests, leather upholstery. Small table **Gemini Square** glossy ebony wood. On the next page: laundry drawer detail of **Palo Alto I-Box** night system in graphite metallic melamine finish with **Flush** handle.

Nelle pagine precedenti: sistema notte **Millimetrica**, fianchi telaio in finitura Canna di Fucile, schienali in Tecno-Marble, attrezzatura interna in melaminico metallizzato Graphite ed ecopelle. Sistema notte **Palo Alto I-Box**, con ante **Narcisse** vetro trasparente complanari, fianchi telaio in alluminio finitura Canna di Fucile, schienali tecno-marble, attrezzatura interna in melaminico metallizzato Graphite, ed ecopelle. Poltrone **Virgin** senza braccioli, rivestimento pelle. Tavolino **Gemini Square** essenza ebano lucido. Nella pagina a fianco: dettaglio cassetto Laundry del sistema notte **Palo Alto I-Box** in finitura nobilitato metallizzato Graphite con maniglia **Flush**.

On the side page: detail of the **Palo Alto I-Box** night system: shoe holder shelf, in melamine graphite metallic finish. Ventilation and purification system with **AirCube** device .

Nella pagina a fianco: dettaglio ripiano porta scarpe del sistema notte **Palo Alto I-Box**, in finitura nobilitato metallizzato Graphite. Sistema di areazione e purificazione dell'area **AirCube**.

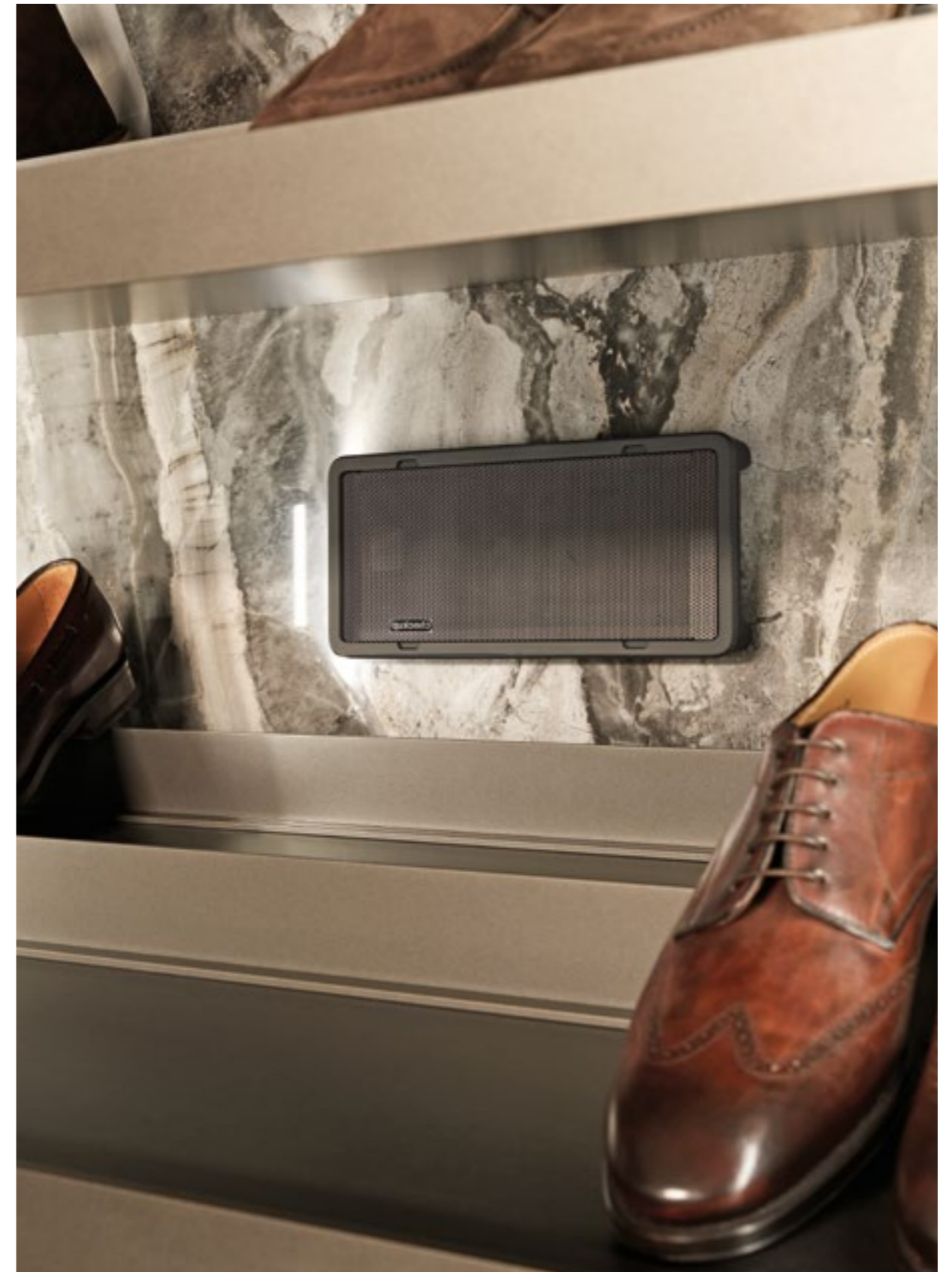



In these pages: **Palo Alto I-Box** night system, with coplanar transparent glass **Narcisse** doors, sides frame in aluminum Gun metal finish, Tecno-Marble backrests, internal equipment consisting of shoe holder and Laundry in graphite metallic melamine, top of the chest of drawers in eco-leather. **Millimetrica** night system, sides frame in aluminum gun metal finish, backrests in Tecno-Marble, internal equipment in melamine metallic Graphite and eco-leather.

In queste pagine: Sistema notte **Palo Alto I-Box**, con ante **Narcisse** vetro trasparente complanari, fianchi telaio in alluminio finitura Canna di Fucile, schienali Tecno-Marble, attrezzatura interna costituita da porta scarpe e Laundry in melaminico metallizzato Graphite, top della cassetiera in ecopelle. Sistema notte **Millimetrica**, fianchi telaio in alluminio finitura Canna di Fucile, schienali in Tecno-Marble, attrezzatura interna in melaminico metallizzato Graphite ed ecopelle.

In these pages: **Palo Alto I-Box** night system, with **Tecno** doors melamine metallic Champagne, sides frame in aluminum finish Gunmetal, backrests melamine Shantung internal equipment in melamine metallic Champagne. **Virgin** armchair with armrests, fabric upholstery.

In queste pagine: Sistema notte **Palo Alto I-Box**, con ante **Tecno** nobilitato metallizzato Champagne, fianchi telaio in alluminio finitura Canna di Fucile, schienali nobilitato Shantung attrezzatura interna in melaminico metallizzato Champagne. Poltrona **Virgin** con braccioli, rivestimento tessuto.





On the side page: detail of the **Palo Alto I-Box** night system interior equipment, sides aluminum frame finish Gunmetal, shelves th.12 mm smoked glass, backrests in melamine finish Shantung, base and top in melamine metallic Champagne. Vertical Zaffiro LED Light.

Nella pagina a fianco: dettaglio attrezzatura interna sistema notte **Palo Alto I-Box**, fianchi telaio in alluminio finitura Canna di fucile, ripiani Sp.12 mm in vetro Fumè e schienali in nobilitato Shantung, basamento e coperchio in nobilitato metallizzato Champagne. Luce Led Zaffiro verticale.



In the previous pages and in these: **Sumo** bed, bi-colored upholstery. Inside headboard in fabric, outside headboard and bed frame in suede leather. **Virgin Sofa**, fabric upholstery. **Stiletto** small table with Marquinia marble top, black painted metal stem and antique Graphite metal base. Pouff **Stone**, Nabuck cover. **Shanghai** bedside table, matt lacquered top, tobacco wooden structure, gunmetal painted metal base. **Moai** small table, lacquered polished color Petrolio.

Nelle pagine precedenti e in queste: letto **Sumo**, rivestimento bi-color, tessuto nella parte interna della testata e pelle scamosciata nella parte esterna della testata e nel giroletto. Divano **Virgin Sofa**, rivestimento tessuto. Tavolino **Stiletto** con piano in marmo Marquinia, stelo in metallo verniciato nero e base metallo Graphite anticato. Pouff **Stone**, rivestimento Nabuck. Comodino **Shanghai**, piano laccato opaco, struttura in essenza tabacco, basamento in metallo verniciato Canna di Fucile. Tavolino **Moai**, laccato lucido petrolio.





On the next page: **Sumo** bed headboard detail, bi-colored upholstery, fabric on the inside of the headboard and suede leather on the outside of the headboard and in the bed frame. **Shanghai** bedside table, matt lacquered top, tobacco wooden structure, gunmetal painted metal base.

Nella pagina a fianco: letto **Sumo**, rivestimento bi-color, tessuto nella parte interna della testata e pelle scamosciata nella parte esterna della testata e nel giroletto. Comodino **Shanghai**, piano laccato opaco, struttura in essenza tabacco, basamento in metallo verniciato Canna di Fucile.

On the side page: detail of **Sumo** Headboard, bi-colored upholstery, Inside headboard in fabric, outside headboard and bed frame in suede leather.

Nella pagina a fianco: dettaglio testata letto **Sumo**, rivestimento bi-color, tessuto nella parte interna della testata e pelle scamosciata nella parte esterna della testata e nel giroletto.





On the side page: **Shanghai** bedside detail, matt lacquered top, tobacco wooden structure, painted metal base Gunmetal. Equipped with LED light.

Nella pagina a fianco: dettaglio comodino **Shanghai**, piano laccato opaco, struttura in essenza tabacco, basamento in metallo verniciato Canna di Fucile. Dotato di luce Led.



In these pages and in the following ones: **Palo Alto I-Box** night system, with **Rex** doors wooden panel Black Oak and aluminum profile finish Gun metal. **Vanity** of the **Palo Alto I-Box** night system, with wall panels in melamine metallic Champagne and smoked natural mirror, aluminum shelf in Gun metal finish, matt lacquered **Maggie** system and leather drawers, desk in black Oak wood. **Cleò** chair, Nabuck seat cover, solid wood base black oak finish. **Virgin Sofa**, fabric upholstery.

In queste pagine e in quelle successive: sistema notte **Palo Alto I-Box**, con ante **Rex** essenza Rovere Nero e profilo in alluminio finitura Canna di Fucile. **Vanity** del sistema notte **Palo Alto I-Box**, con boiserie in nobilitato metallizzato Champagne e specchio naturale Fumè, mensola in alluminio in finitura Canna di Fucile, sistema **Maggie** laccato opaco e cassetti in cuoio, scrivania in essenza Rovere nero. Sedia **Cleò**, rivestimento seduta in Nabuck, base massello finitura Rovere Nero. Divano **Virgin Sofa**, rivestimento tessuto.





On the side page: **Vanity** detail of the **Palo Alto I-Box** night system, matt lacquered **Maggie** and leather drawers, desk in black Oak wood. **Cleò** chair, Nabuck seat covering, solid base black oak finish.

Nella pagina a fianco: dettaglio **Vanity** del sistema notte **Palo Alto I-Box**, sistema **Maggie** laccato opaco e cassetti in cuoio, scrivania in essenza Rovere nero. Sedia **Cleò**, rivestimento seduta in Nabuck, base massello finitura Rovere Nero.

In these pages: **Vanity** of the **Palo Alto I-Box** night system, with wall panels in melamine Metallic champagne and smoked natural mirror, aluminum shelf in Gun metal finish, matt lacquered **Maggie** system and leather drawers, desk in black oak wood. **Cleò** chair, Nabuck seat covering, solid base black oak finish.

In queste pagine: **Vanity** del sistema notte **Palo Alto I-Box**, con boiserie in nobilitato metallizzato Champagne e specchio naturale Fumè, mensola in alluminio in finitura Canna di Fucile, sistema **Maggie** laccato opaco e cassetti in cuoio, scrivania in essenza Rovere nero. Sedia **Cleò**, rivestimento seduta in Nabuck, base massello finitura Rovere.



**INTERIOR
INSPIRATION,
NEW CONCEPT.**







In the previous pages and in these pages: corner sofa **Argo** fabric cover. Small table **Rialto 3/4**, smoked glass top based on black painted metal and antiqued brass. **Sirius** small table, Calacatta gold marble top, nickel-plated gold metal structure. Three small tables **Stiletto** with top respectively in Calacatta gold, Orobico marble and wood veneer color tabacco, painted metal stem in combination with the top and metal base Antiqued brass. Small table **Gemini Round** shape, top in wood veneer Ebony glossy. **Virgin** armchair with armrests, fabric upholstery. **Virgin Round** love seat, Nabuck leather cover.

Nelle pagine precedenti e in queste pagine: divano ad angolo **Argo** rivestimento tessuto. Tavolino **Rialto 3/4**, piano vetro fumè base metallo verniciato nero e ottone anticato. Tavolino **Sirius**, top marmo Calacatta oro, struttura metallo oro nichelato. Tre tavolini **Stiletto** con piano rispettivamente in marmo Calacatta oro, Orobico ed Essenza tabacco, stelo in metallo verniciato in abbinamento al piano e base metallo Ottone anticato. Tavolino **Gemini Round** Essenza Ebano lucido. Poltrona **Virgin** con braccioli, rivestimento tessuto. Divanetto **Virgin Round**, rivestimento Nabuck.

On the side page: detail of the **Argo** sofa end element
with glossy wood veneer Ebony support top.

Nella pagina a fianco: dettaglio dell'elemento
terminale divano **Argo** con piano in appoggio Essenza
Ebano lucido.





In these pages: Sofa **Virgin Round** upholstery Nabuck leather. **Stiletto** small table, Marquinia top, black painted metal stem, painted metal base Graphite antiqued.

In queste pagine: divano **Virgin Round** rivestimento Nabuck. Tavolino **Stiletto**, piano Marquinia, stelo metallo verniciato nero, base metallo verniciato Graphite anticato.



On the side page: detail of the back of **Virgin** armchair with armrests, with fabric upholstery.

Nella pagina a fianco: dettaglio della parte posteriore della poltrona **Virgin** con braccioli, con rivestimento in tessuto.

In these pages: **Virgin** armchair with armrests, fabric upholstery. **Stiletto** small table polished lacquered top and white Gesso, painted metal stem color white Gesso, painted metal base antiqued brass.

In queste pagine: poltrona **Virgin** con braccioli, rivestimento tessuto. Tavolino **Stiletto** piano laccato lucido e gesso, stelo metallo verniciato Gesso, base metallo verniciato Ottone anticato.





In the previous pages and in these pages: Table **Ala Round** Orobico marble top, base and **Lazy Susan** painted Dark Bronze antiqued. **Virgin** dining chairs with armrest, bi-colored upholstery, leather back and fabric front. Sideboard **Milvian** high double-sided, marble top Calacatta gold, shaped sides in bronze painted aluminum, fronts in Black Oak Wood. Wall unit composition **Urban** structure melamine Dark Bronze and Black dyed Oak.

Nelle pagine precedenti e in queste pagine: tavolo **Ala Round** piano marmo Orobico, basamento e **Lazy Susan** verniciato Dark Bronze anticato. Sedie **Virgin** con bracciolo rivestimento bi-color, retro in pelle e fronte in tessuto. Madio **Milvian** alte bifacciali, piano marmo Calacatta oro, spalle sagomate in alluminio verniciato Bronzo, frontali in Essenza Rovere nero. Composizione **Urban** struttura Nobilitato Dark Bronze e Rovere Tinto Nero.



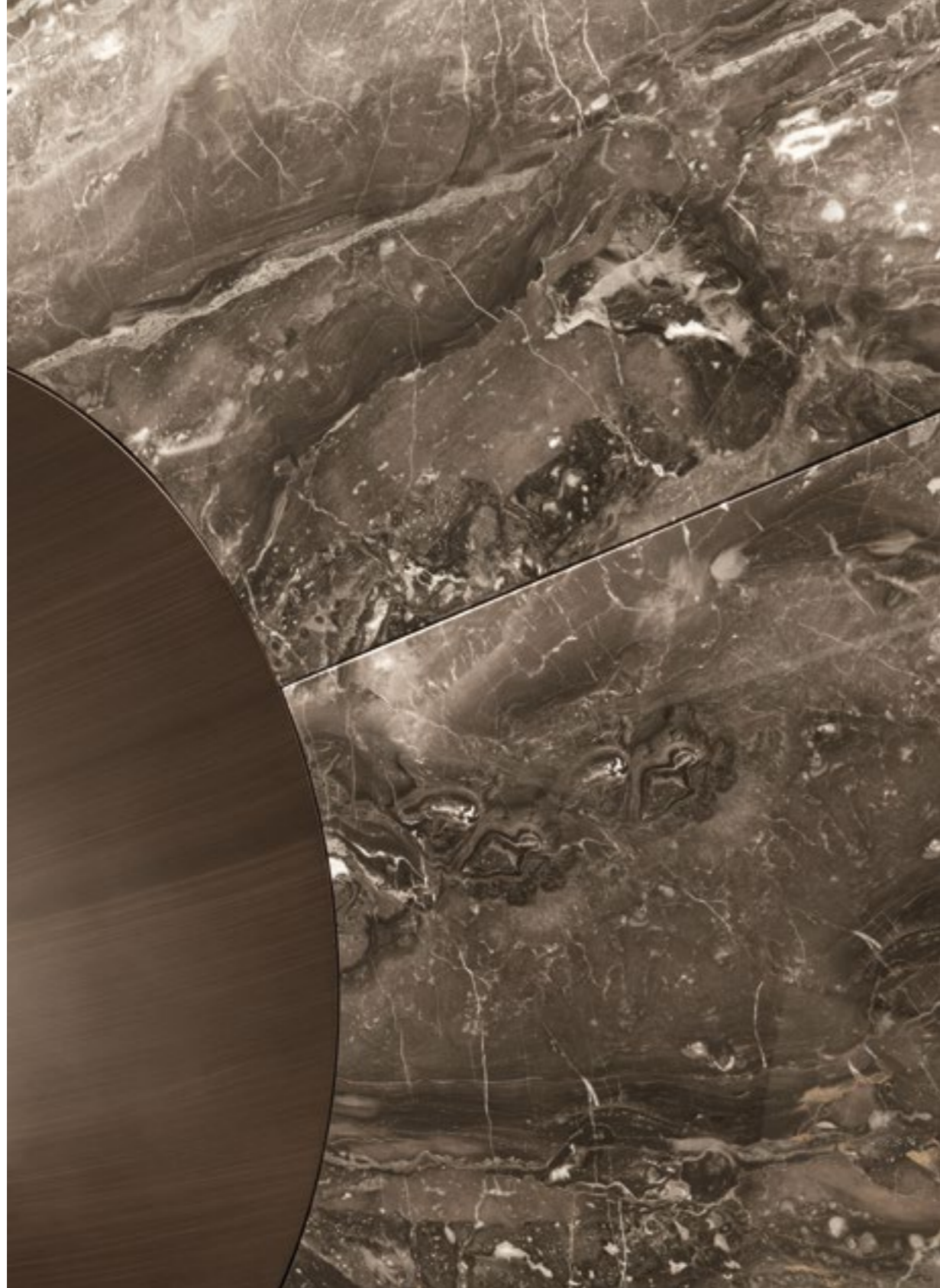

On the side page: detail table top **Ala Round** in Orobico marble top with **Lazy Susan** painted Dark Bronze.

Nella pagina a fianco: dettaglio piano tavolo **Ala Round** in marmo Orobico con **Lazy Susan** verniciato Dark Bronze.



In these pages: **Virgin** dining chairs with armrests
bi-colored upholstery, leather back and fabric front.

In queste pagine: sedie **Virgin** con braccioli
rivestimento bi-color, retro in pelle e fronte in tessuto.

On the side page: detail of the **Virgin** dining armchair with bi-colored upholstery, leather back and fabric front.

Nella pagina a fianco: dettaglio parte superiore della sedia **Virgin** con braccioli rivestimento bi-color, retro in pelle e fronte in tessuto.





On the side page: Sideboard **Milvian** double-sided high version, Calacatta gold marble top, shaped sides in bronze painted aluminum, fronts in black Oak wood, glossy lacquered internal structure Toffee color.

Nella pagina a fianco: Madie **Milvian** alte bifacciali, piano marmo Calacatta oro, spalle sagomate in alluminio verniciato Bronzo, frontali in Essenza Rovere nero, struttura interna laccata lucido Toffee.

Nella pagina a fianco: particolare del piano della madia
Milvian, piano marmo Calacatta oro, spalle sagomate
in alluminio verniciato Bronzo, frontali in Essenza
Rovere nero.

Nella pagina a fianco: particolare del piano della madia
Milvian, piano marmo Calacatta oro, spalle sagomate
in alluminio verniciato Bronzo, frontali in Essenza
Rovere nero.



In these pages: Table **Ala Round** Orobico marble top, legs and **Lazy Susan** painted Dark Bronze antiqued. **Virgin** dining armchairs, bi-colored upholstery, leather back and fabric front. **Urban** wall unit composition Melamine Dark Bronze Structure and Black dyed Oak.

In queste pagine: tavolo **Ala Round** piano marmo Orobico, basamento e **Lazy Susan** verniciato Dark Bronze anticato. Sedie **Virgin** con bracciolo rivestimento bi-color, retro in pelle e fronte in tessuto. Composizioni **Urban** struttura Nobilitato Dark Bronze e Rovere Tinto Nero.





On the side page: **Virgin** dining chair without armrests
fabric cover.

Nella pagina a fianco: sedia **Virgin** senza braccioli
rivestimento tessuto.





In the previous pages: **Argo** linear sofa, fabric upholstery, armrests in glossy ebony wood. **Virgin** armchairs without armrests, leather upholstery. **Stiletto** small table with Calacatta gold marble top, metal stem painted white Gesso, base metal painted antiqued brass. Side table **Moai** lacquered glossy Black. **Sirius** small table, Calacatta gold marble top, nickel-plated gold metal structure. Pouff **Stone**, suede upholstery. On the side page: **Virgin** armchairs without armrests, leather upholstery. **Stiletto** small table with Orobico marble top, black painted metal stem, antique Graphite painted metal base.

Nelle pagine precedenti: divano lineare **Argo**, rivestimento tessuto, braccioli in essenza ebano lucido. Poltrone **Virgin** senza braccioli, rivestimento pelle. Tavolino **Stiletto** con piano in marmo Calacatta oro, stelo metallo verniciato gesso, base metallo verniciato Ottone anticato. Tavolino **Moai** laccato lucido Nero. Tavolino **Sirius**, top marmo Calacatta oro, struttura metallo oro nichelato. Pouff **Stone**, rivestimento pelle scamosciata.

Nella pagina a fianco: poltrone **Virgin** senza braccioli, rivestimento pelle. Tavolino **Stiletto** piano marmo Orobico, stelo metallo verniciato Nero, base metallo verniciato Graphite anticato.

On the side page: **Stiletto** console, black oak wooden top, black painted metal stem, antique Graphite painted metal base.

Nella pagina a fianco: consolle **Stiletto** piano essenza Rovere Nero, stelo metallo verniciato Nero, base metallo verniciato Graphite anticato.







In the previous pages and in these pages: **Virgin** bed, fabric upholstery. Bedside tables **Eros** marble top Calacatta Oro, structure Black Oak wood, base metal painted bronze. Chest of drawers **Eros** marble top in marble Marquinia, structure Black Oak wood, base metal painted bronze. Pouff **Stone**, nabuck leather cover.

Nelle pagine precedenti e in queste pagine: letto **Virgin**, rivestimento tessuto. Comodini **Eros** piano marmo Calacatta Oro, struttura essenza Rovere Nero, basamento metallo verniciato bronzo. Comò **Eros** piano marmo Marquinia, struttura essenza Rovere Nero, basamento metallo verniciato bronzo. Pouff **Stone**, rivestimento nabuck.

On the side page: detail **Eros** bedside table in Calacatta gold marble.

Nella pagina a fianco: dettaglio piano comodino **Eros** in marmo Calacatta oro.







In the previous pages: front view of **Virgin** bed, fabric upholstery. On the next page: detail headboard **Virgin** bed, covered in fabric.

Nelle pagine precedenti: vista frontale letto **Virgin**, rivestimento tessuto. Nella pagina a fianco: dettaglio testata letto **Virgin**, rivestita in tessuto.

In these pages: **Eros** chest of drawers with Marquinia marble top, black oak wood structure, bronze painted metal base.

In queste pagine: comò **Eros** piano marmo Marquinia, struttura essenza Rovere Nero, basamento metallo verniciato bronzo.



On the side page: detail joint base and **Eros** chest of drawers top, Marquinia marble top, bronze painted metal base.

Nella pagina a fianco: dettaglio incastro basamento e piano comò **Eros**, piano in marmo Marquinia, basamento metallo verniciato bronzo.





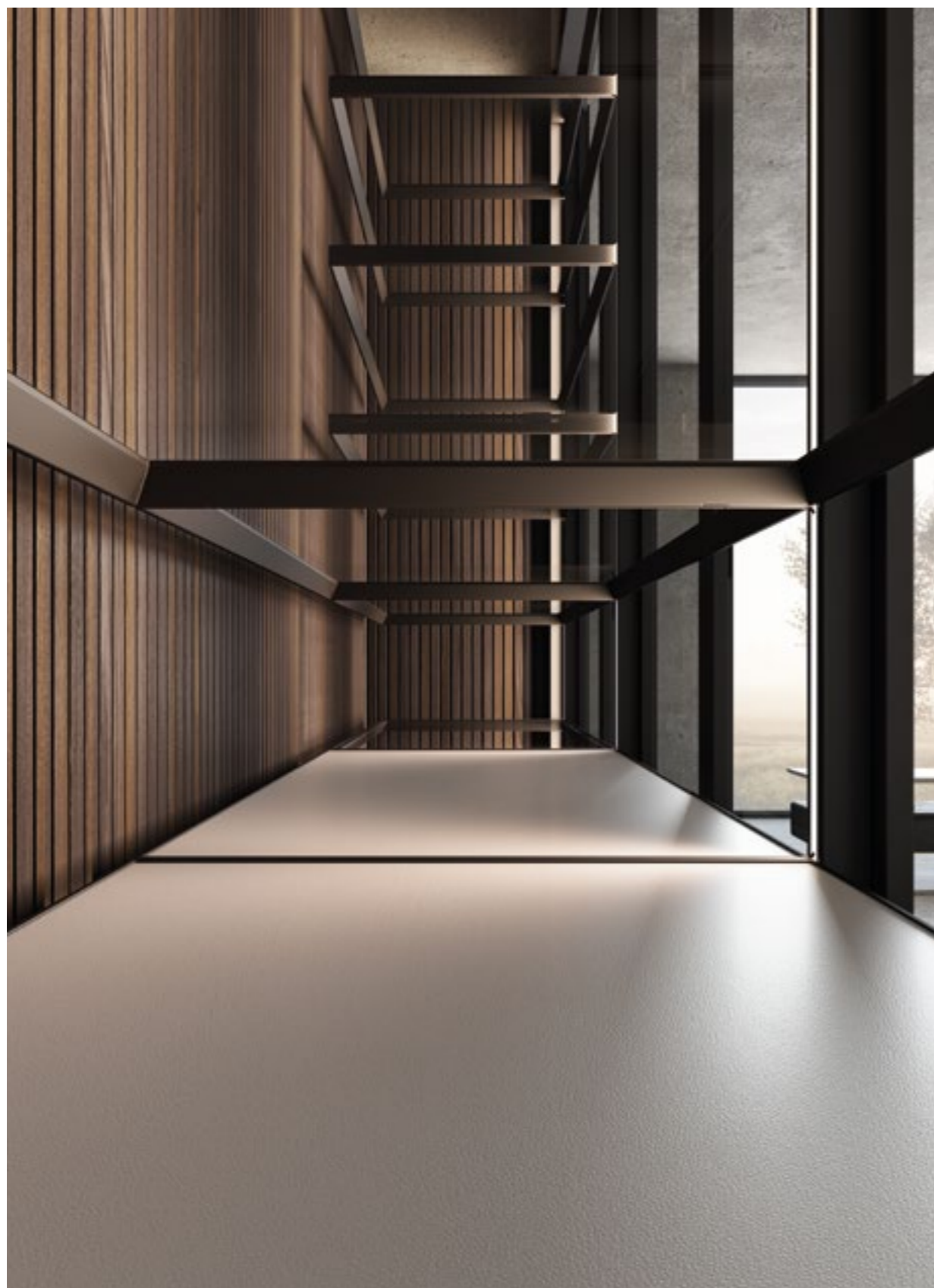

In the previous pages and on the side page: **Palo Alto Free** night system, with transparent glass **Rex** doors, suspended chests of drawers finish in melamine silk shantung with Cardea handles and eco-leather top, Framed shelves in transparent glass, metal parts painted gun metal. Chest of drawers **Eros** marble top Marquinia, structure Black Oak wood, base metal painted bronze. Pouff **Virgin**, Nabuck leather cover. **Virgin** bed, fabric upholstery.

Nelle pagine precedenti e nella pagina a fianco: sistema notte **Palo Alto Free**, con ante **Rex** vetro trasparente, cassettiere sospese nobilitato shantung di seta con maniglie cardea e top in ecopelle, ripiani Frame in vetro trasparente, parti in metallo verniciate canna di fucile. Comò **Eros** piano marmo Marquinia, struttura essenza Rovere Nero, basamento metallo verniciato bronzo. Pouff **Virgin**, rivestimento nabuck. Letto **Virgin**, rivestimento tessuto.

On the side page: detail of the internal equipment **Palo Alto Free** night system, suspended chests of drawers finish silk shantung melamine with eco-leather top and frame shelves in transparent glass. Vertical Sapphire LED light.

Nella pagina a fianco: dettaglio attrezzatura interna sistema notte **Palo Alto Free**, cassettiere sospese nobilitato shantung di seta con top in ecopelle e ripiani Frame in vetro trasparente. Luce Led Zaffiro verticale.

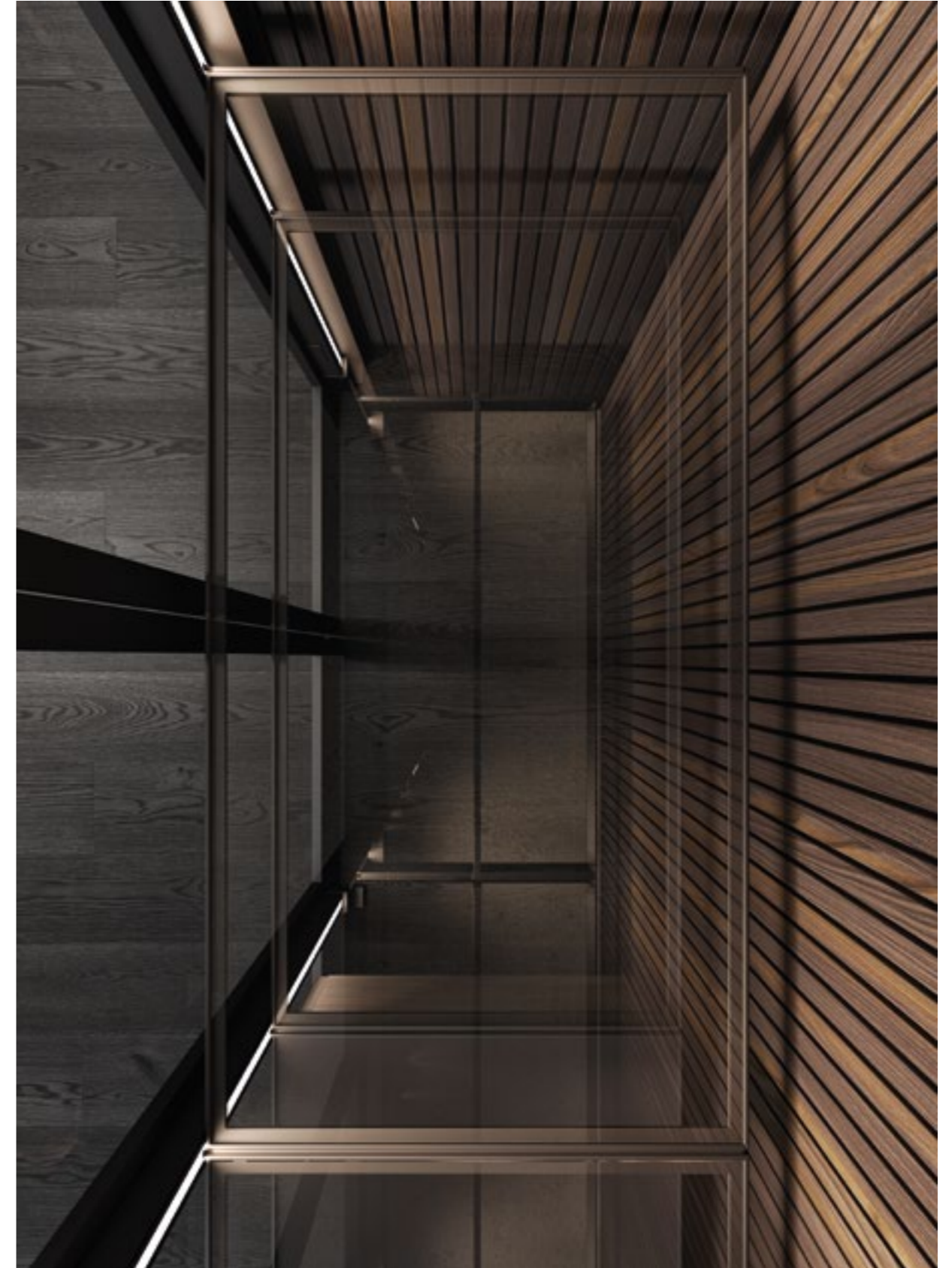





In the previous pages and on the side page: **Palo Alto I-Box** night system, with **Puzzle** doors finished in melamine Cementino White, integrated at **Puzzle Boserie** system, in melamine Cementino White finishing, and with varnished gun metal profiles. **Palo Alto Wall** night system, with back panels in Millerighe Eucalipto Veneer. Pouff **Stone**, quilted nabuck leather cover. Coffe table **Rialto**, Fumè transparent top and black and antique brass painted metal based.

Nelle pagine precedenti e nella pagina a fianco: sistema notte **Palo Alto I-Box**, ante **Puzzle** Cementino White, integrato al sistema **Boserie Puzzle** in finitura Cementino White, con profili verniciati canna di fucile. Sistema notte **Palo Alto Wall**, schienale in Essenza Millerighe Eucalipto. Pouff **Stone**, rivestimento nabuck trapuntato. Tavolino **Rialto** intero, piano vetro fumè trasparente, base metallo verniciato nero e ottone anticato.



In the previous pages, on the next page and in the following ones: **Palo Alto Wall** night system, with back panels in Millerighe Eucalipto Veneer, suspended chests of drawers finish in melamine silk shantung with **Cardea** handles and eco-leather top, Frame shelves in fumè transparent glass, hanging-bars in eco-leather and metal parts painted in gun metal. Pouff **Stone**, quilted nabuck leather cover. Small table **Rialto**, Fumè transparent top and black and antique brass painted metal based.

Nelle pagine precedenti, nella pagina a fianco e in quelle successive: Sistema notte **Palo Alto Wall**, schienale in Essenza Millerighe Eucalipto, cassettiere sospese nobilitato shantung di seta con maniglie **Cardea** e top ecopelle, ripiani Frame in vetro Fumè trasparente, tubi appendi abito in ecopelle e parti metallo verniciate canna di fucile. Pouff **Stone**, rivestimento nabuck trapuntato. Tavolino **Rialto** intero, piano vetro fumè trasparente, base metallo verniciato nero e ottone anticato.





In these pages: **Sofa Virgin**, Nabuck leather upholstery. Small table **Moai** lacquered polish Black. **Janus** small table, Semi-oval top in Marquinia marble, base in black painted metal and gold nickel-plated cross.

In queste pagine: divano **Virgin Sofa**, rivestimento Nabuck. Tavolino **Moai** laccato lucido Nero. Tavolino **Janus**, piano Semi-ovale in marmo Marquinia, base in metallo verniciato nero e croce Nichelata oro.





On the side page: detail of the seam and back leg of the **Virgin Sofa**, Nabuck upholstery.

Nella pagina a fianco: dettaglio della cucitura e della gamba posteriore del divano **Virgin Sofa**, rivestimento Nabuck.

On the next page: detail of the seam of the front seat of
the **Virgin Sofa**, Nabuck upholstery.

Nella pagina a fianco: dettaglio della cucitura della
seduta anteriore del divano **Virgin Sofa**, rivestimento
Nabuck.



STILL



LIFE.

Nelle pagine seguenti vengono proposte una serie di ambientazioni stilizzate, volte a suggerire l'immagine e lo stile di MisuraEmme nella progettazione delle diverse aree della casa.

Queste ambientazioni sono caratterizzate sia dall'accostamento dei diversi prodotti, sia dalla scelta delle finiture degli stessi, che dalla scelta delle finiture dell'ambiente.

Il tutto caratterizza l'identità aziendale e le proposte progettuali suggerite da MisuraEmme.

The following pages offer a series of stylized settings, aimed to suggest the image and style of MisuraEmme in the design of the different areas of the house. These settings are characterized both by the combination of different products, both by the choice of their finishes, and by the choice of environment finishes. All this characterizes the corporate identity and the design proposals suggested by MisuraEmme.



1 Sistema Puzzle

- Pannelli boiserie in melaminico Cementino White ed essenza Wave Noce Canaletto, profili verniciato Canna di Fucile 524.

- Teke spalle e ripiani vetro Extralight V00 e schienali vetro acidato Sand X9F,
- Contenitore in vetro verniciato Sepia 13 con interno laccato opaco Sepia 13, profili verniciati Canna di Fucile 524.
- Mensole verniciato Canna di Fucile 524

Dimensioni: L. 7719 x P. 500 mm

2 Sistema Puzzle

- Pannelli boiserie in melaminico Cementino White ed essenza Wave Noce Canaletto, profili verniciato Canna di Fucile 524

- Teke spalle e ripiani vetro Extralight V00 e schienali vetro acidato Sand X9F

Dimensioni: L. 4795 x P. 300 mm

3 Eros media

Finitura piano Marmo Calacatta Oro OR, contenitori essenza Rovere Nero 51, struttura metallo Bronzo 528

Dimensioni: L. 2000 x P. 535 x H. 503 mm

4 Divano Argo

Composto da:

- Elemento terminale sx inclinato 30°, rivestito in tessuto Tundra D2F tortora, L. 2493 x P. 1588 x H. 770 mm - piano appoggio essenza Eucalipto 54
- Pouf rivestito in tessuto Tundra D2F tortora, L. 1470 x P. 970 x H. 390 mm - piano appoggio essenza Eucalipto 54
- N°1 cuscino Clovis H. 500 x L. 500 mm rivestiti in tessuto Tundra D2F
- N°1 cuscino Clovis H. 500 x L. 500 mm rivestiti in pelle trauntata H34 fango
- N°2 inserto retro cuscini rivestiti in pelle trauntata H34 fango

5 Virgin round sofa

Rivestimento in tessuto Yellowstone E96 Rugiada.

- N°1 cuscino Alison H. 500 x L. 500 rivestimento in Nabuck N13 Orso bruno

Dimensione: L. 1700 x P. 935 x H. 720 mm

6 Virgin poltrona con braccioli

Rivestimento in Nabuk N13 Orso bruno.

Dimensione: L. 700 x P. 780 x H 700 mm

7 Stiletto tavolino

Finitura piano in marmo Calacatta Oro CA, stelo laccato opaco Gesso 01, base in Dark Bronze Anticato 5R.

Dimensione: Ø 800 x H 323 mm

8 Rialto tavolino

Finitura piano in vetro Trasparente Fumè V05, base in metallo verniciato Nero 538 e Ottone Anticato 537.

Dimensione: Ø 700 x H 420 mm

9 Sirius tavolino

Finitura piano in marmo Rosso Lepanto, base Nichelato Oro 502.

Dimensione: Ø 300 x H 480 mm

10 Moai tavolino

Laccato lucido Melange L93.

Dimensione: Ø 350 x H 460 mm

11 Stone pouf

Rivestimento in pelle liscia H34 con parte superiore trapuntata.

Dimensione: L. 1050 x P. 1050 x H 400 mm

1 Puzzle system

- Boiserie panels in Cementino White melamine and Wave Noce Canaletto wood, profiles in Gun metal varnished 524,

- Display cases with side and shelves in Extralight V00 glass and back in frosted varnished glass Sand X9F

- Drawers in varnished glass Sepia 13 with internal structure in Sepia 13 matt lacquered, profiler Gun Metal 524 varnished.

- Shelves in Gun metal varnished 524

Dimension: L. 7719 x D. 500 mm

2 Puzzle system

- Boiserie panels in Cementino White melamine and Wave Noce Canaletto wood, profiles in Gun metal varnished 524

- Display cases with side and shelves in Extralight V00 glass and back in frosted varnished glass Sand X9F

Dimensions: L. 4795 x D. 300 mm

3 Eros sideboard

Top in Calacatta Oro CA marble, drawers in Rovere Nero 51 wood, structure in metal Bronze 528

4 Divano Argo

Composed of:

- Left 30 ° corner, upholstery in Tundra D2F tortora L. 2493 x D. 1588 x H. 770 mm - armrest in Eucalyptus 54
- Pouf upholstery in Tundra D2F tortora, W. 1470 x D. 970 x H. 390 mm - armrest in Eucalyptus 54
- N ° 1 Clovis cushions H. 500 x L. 500 mm upholstered in Tundra D2F tortora fabric
- N ° 1 Clovis cushions H. 500 x L. 500 mm upholstered in Quilted leather H34 fango
- N ° 1 back cushion upholstered in Quilted leather H34 fango

5 Virgin round sofa

Upholstery in fabric Yellowstone E96 Rugiada.

- N°1 cuscino Alison H. 500 x L. 500 upholstery in Nabuck N13 Orso bruno

Dimensions: L. 700 x D. 935 x H. 720 mm

6 Virgin armchair with armrest

Upholstery in Nabuck N13 Orso bruno.

Dimensions: L. 700 x D. 780 x H. 700 mm

7 Stiletto small table

Top in Calacatta Oro CA marble, stem in Gesso 01 matt lacquered,

base in Antique Dark Bronze 5R.

Dimensions: Ø 800 x H 323

8 Rialto small table

Top in Fumè Trasparent glass V05, base in Black 538 varnished metal and Antique Brass painted metal 537.

Dimensions: Ø 700 x H 420

9 Sirius tavolino

Top in o Rosso Lepanto, marble, base in Nichelato Oro 502.

Dimensions: Ø 300 x H 480 mm

10 Moai tavolino

Glossy lacquered Melange L93 finish.

Dimensions: Ø 350 x H 460 mm

11 Stone pouf

Upholstery in smooth leather H34 with quilted top.

Dimensions: L. 1050 x D. 1050 x H 400

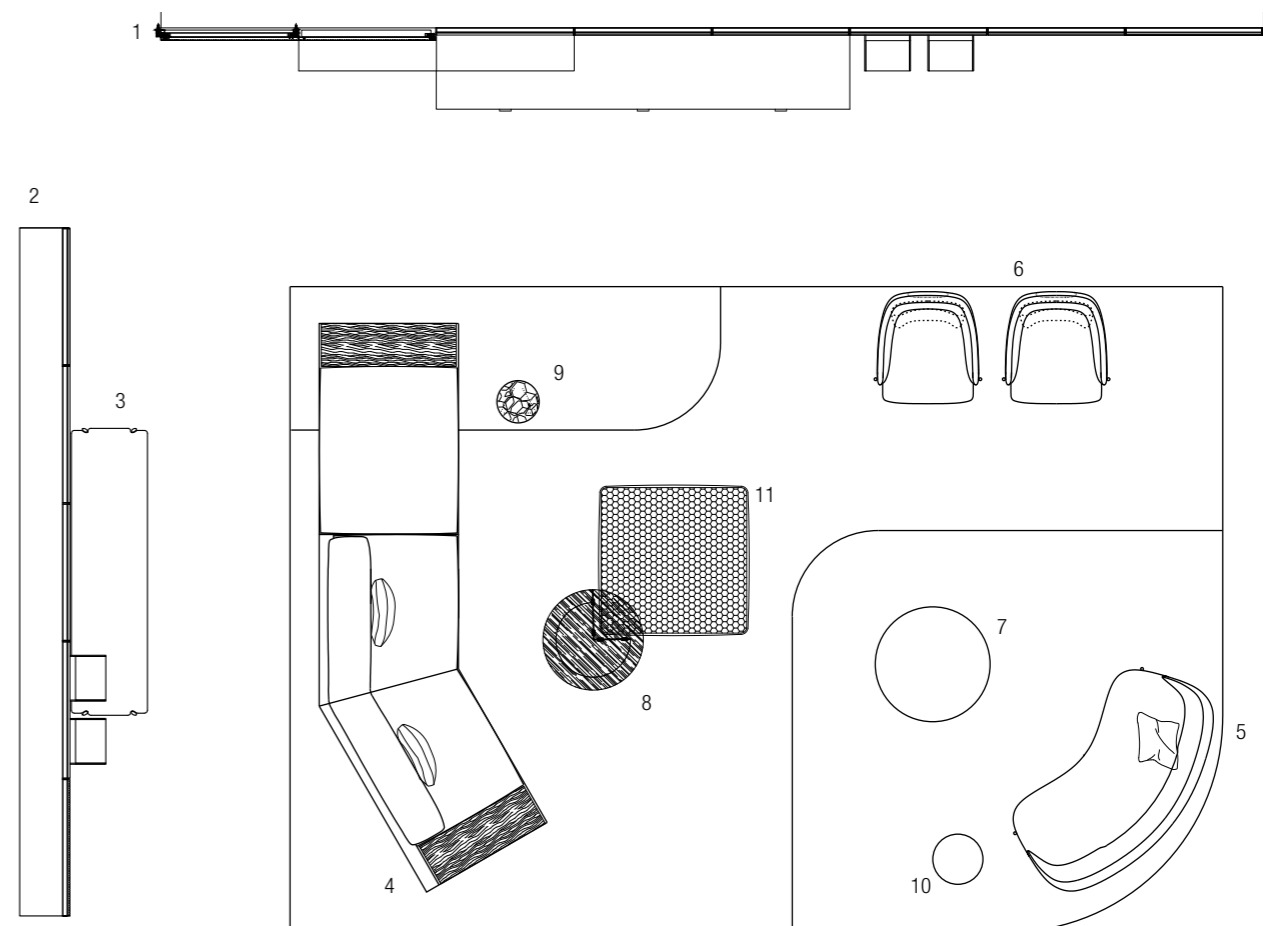

Sistema Puzzle

Puzzle system

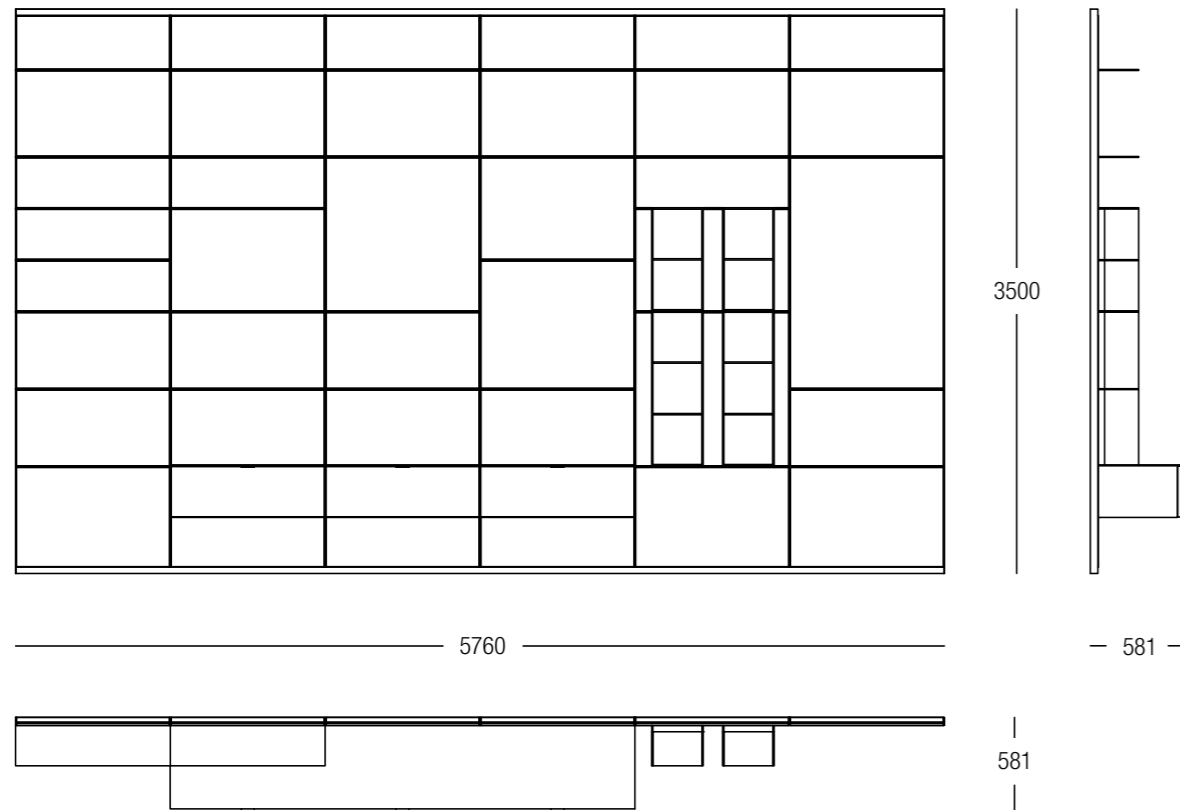

Sistema Puzzle

Puzzle system

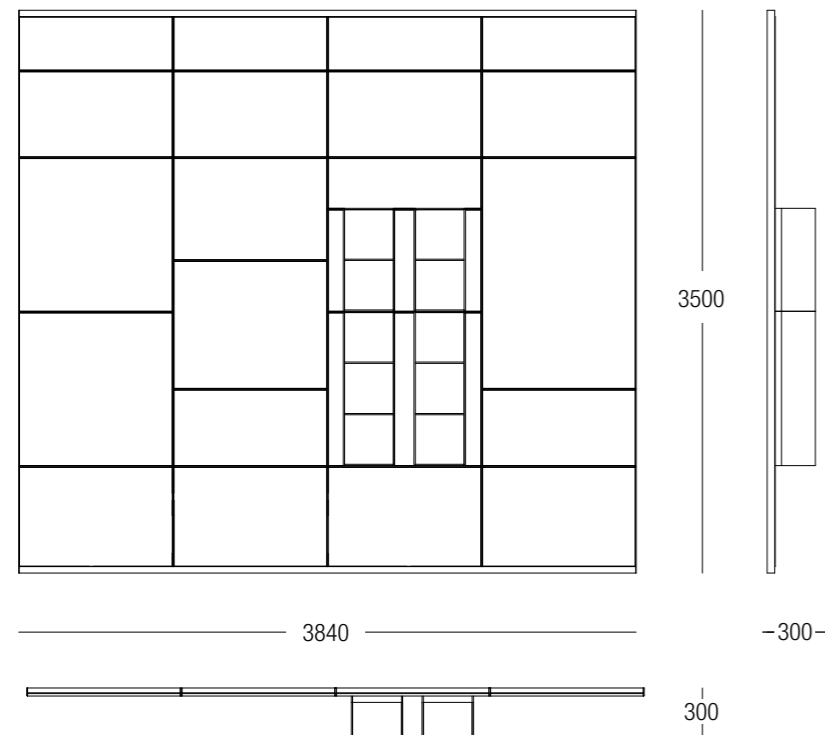

Divano Argo

Argo sofa

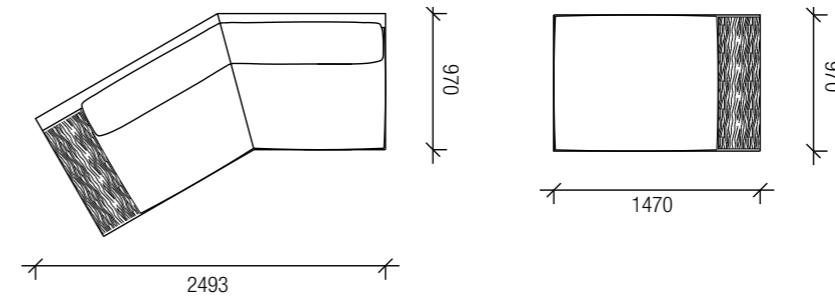

Virgin round sofa

Virgin round sofa

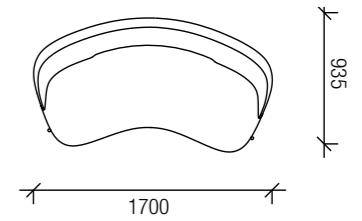

Poltrona Virgin

Argo sofa

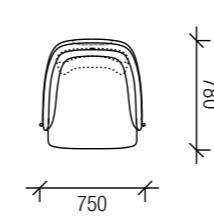

Pouf Stone

Stone pouf

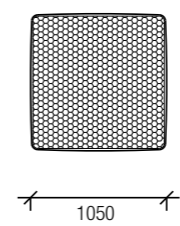

Madia Eros

Eros Sideboard

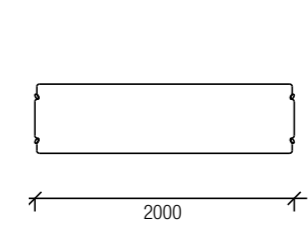

Tavolino Stiletto

Stiletto small table

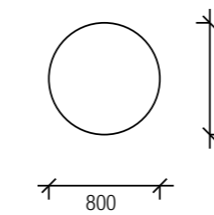

Tavolino Rialto

Rialto small table

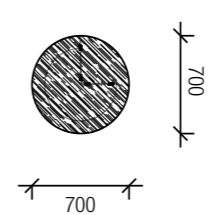

Tavolino Moai

Moai small table

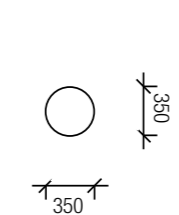

Tavolino Sirius

Sirius small table

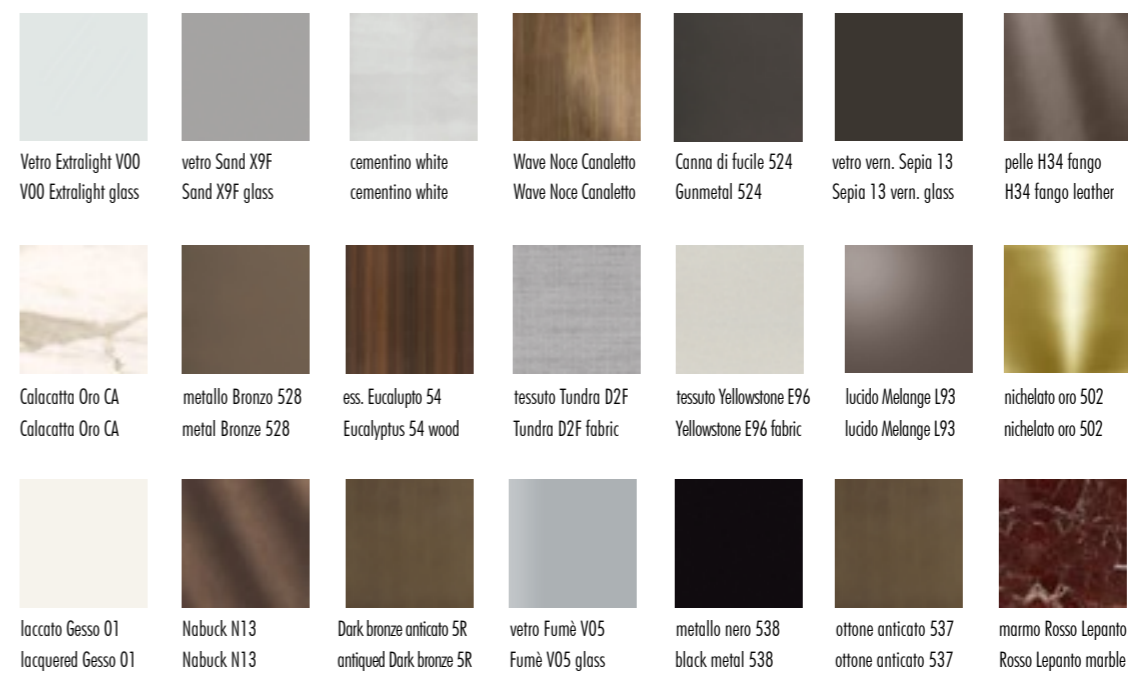
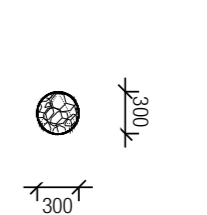



1 Argo divano

Composto da:
 - Elemento terminale sx L. 2040 x P. 970 x H. 770 mm - bracciolo L. 100 mm - cuscino seduta intero, rivestito in tessuto Tulsa C85.
 - Pouf L. 1470 x P. 970 x H. 390 mm - piano appoggio L. 300 x P. 490 x H. 390 mm rivestito in tessuto Tulsa C85 e finitura piano appoggio essenza Ebano lucido L62.
 - Elemento terminale dx inclinato 30° L. 2493 x P. 1588 x H. 770 mm - bracciolo L. 300 mm - cuscino seduta intero, rivestito in tessuto Tulsa C85
 - N° 2 cuscini Alison H. 500 x L. 500 mm in tessuto Tulsa C85
 - N° 2 cuscini Alison H. 500 x L. 500 mm rivestiti in Pelle trapuntata H73
 - N° 4 poggiatesta opzionale in Pelle trapuntata H73

2 Janus console

Finitura piano in marmo Calacatta Oro CA e base Metallo verniciato nero 538 e crociera Nichelata Oro 502. Dimensioni: L. 1200 x P. 450 x H. 620 mm

3 Milvian madia bassa bifacciale

Finitura top in marmo Calacatta Oro CA, spalle sagomate in alluminio verniciate Bronzo 528, frontali in essenza Ebano lucido L62, struttura interna laccata lucida Marsala L94. Dimensioni: L. 1990 x P. 516 x H. 745 mm

4 Virgin poltrona con braccioli

Rivestimento bi-color: retro in Pelle nera H73 e fronte in tessuto Gong E66, base in Metallo verniciato nero 538. Dimensioni: L. 700 x P. 780 x H. 700 mm

5 Gemini tavolino quadrato

Finitura essenza Ebano lucido L62. Dimensioni: L. 1000 x P. 1000 x H. 242 mm

6 Moai tavolino

Finitura laccato lucido Petrolio L9H. Dimensioni: Ø 350 x H. 460 mm

7 Sirius tavolino

Finitura struttura Nichelato Oro 502, finitura piano in marmo Calacatta Oro CA. Dimensioni: Ø 350 x H. 480 mm

1 Argo sofa

Composed of:
 - Left terminal element W. 2040 x D. 970 x H. 770 mm - armrest L. 100 mm - full seat cushion, upholstered in Tulsa C85 fabric.
 - Pouf W. 1470 x D. 970 x H. 390 mm - W. 300 x D. 490 x H. 390 mm upholstered in Tulsa C85 fabric and glossy Ebony wooden top finish L62.
 - Right 30° corner L. 2493 x D. 1588 x H. 770 mm - armrest L. 300 mm - full seat cushion, upholstered in Tulsa C85 fabric
 - N° 2 Alison cushions H. 500 x L. 500 mm in Tulsa C85 fabric
 - N° 2 Alison cushions H. 500 x L. 500 mm upholstered in H73 quilted Leather
 - N° 4 optional headrest in H73 quilted Leather

2 Janus console

Top in Calacatta Oro CA marble and black painted Metal 538 base with Gold Nickel plated 502 crosspiece. Dimensions: L. 1200 x D. 450 x H. 620 mm

3 Milvian low double-sided sideboard

Top in Calacatta Oro CA marble, shaped aluminum sides painted Bronze 528, fronts in glossy Ebony L62, internal structure lacquered in glossy Marsala L94. Dimensions: L. 1990 x D. 516 x H. 745 mm

4 Virgin armchair with armrests

Two-tone upholstery: back in black Leather H73 and front in Gong E66 fabric, base in black painted Metal 538. Dimensions: L. 700 x D. 780 x H. 700 mm

5 Gemini squared small table

Glossy Ebony wood L62 finish. Dimensions: L. 1000 x P. 1000 x H. 242 mm

6 Moai small table

Glossy lacquered Petrolio L9H finish. Dimensions: Ø 350 x H. 460 mm

7 Sirius small table

Nickel Gold plated 502 structure with Calacatta Oro CA marble top. Dimensions: Ø 350 x H. 480 mm

Argo divano

Argo sofa

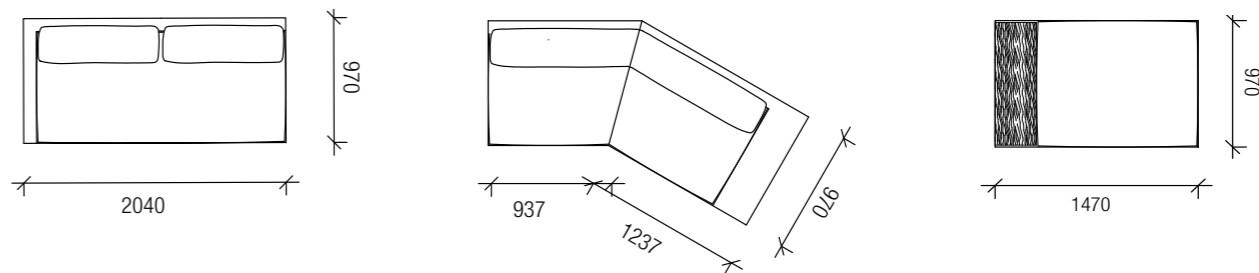

Janus console

Janus console

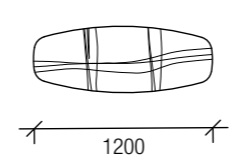

Milvian madia bassa bifacciale

Milvian low double-sided sideboard

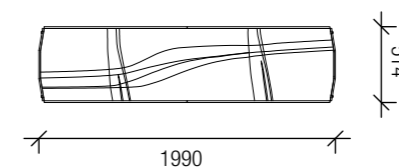

Moai tavolino

Moai small table

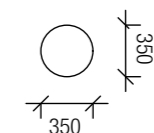

Alison cuscino

Alison cushion

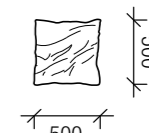

Sirius tavolino

Sirius small table

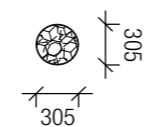

Gemini tavolino

Gemini small table

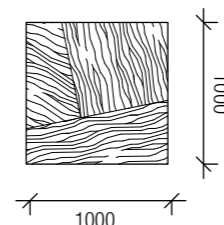

Virgin poltrona

Virgin armchair

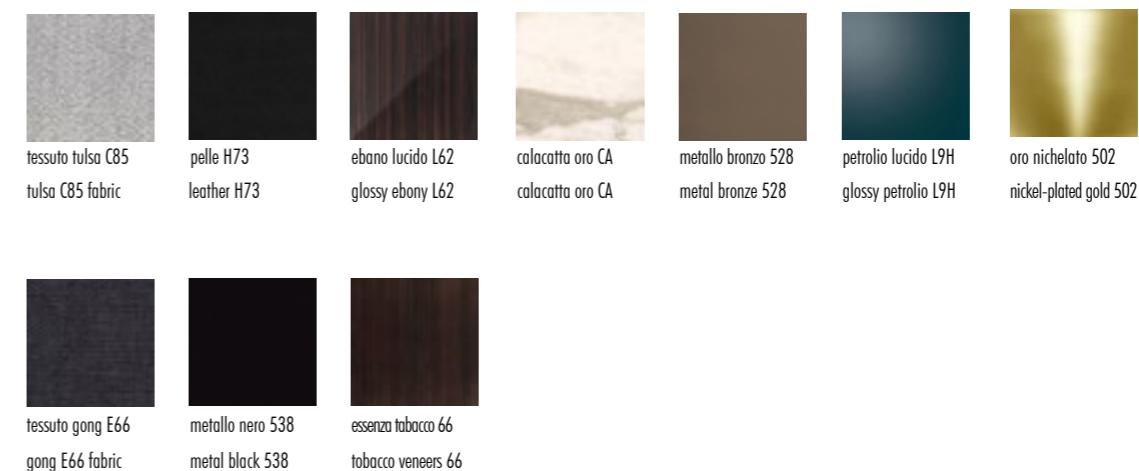
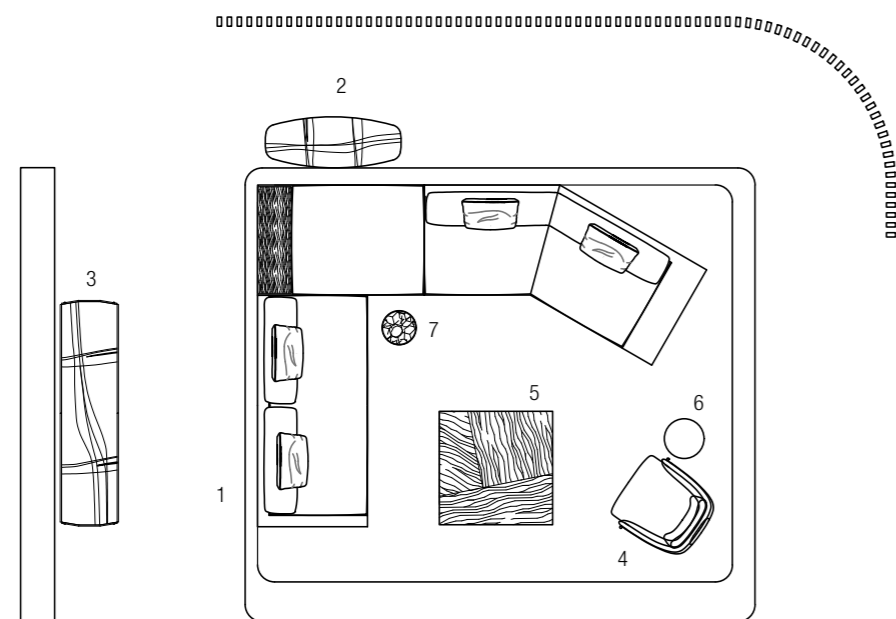
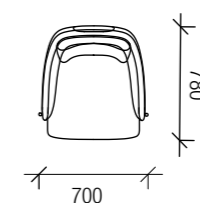



1 Argo divano

- Composto da:
- Elemento terminale sx inclinato 30° L. 2493 x P. 1588 x H. 770 mm - bracciolo L. 300 mm - cuscino seduta intero, rivestito in tessuto Brera D33
 - Pouf L. 1470 x P. 970 x H. 390 mm - piano appoggio L. 300 x P. 490 H. 160 mm rivestito in tessuto Brera D33 e finitura piano appoggio essenza Ebano lucido L62
 - Elemento terminale dx L. 2240 x P. 970 x H. 770 mm - piano in appoggio L. 300 x P. 840 x H. 160 mm - cuscino seduta intero, rivestito in tessuto Brera D33 e finitura piano appoggio essenza Ebano lucido L62
 - Chaise longue inclinata 45° L. 1756 x P. 1706 x H. 770 mm _ cuscino seduta intero, rivestito in tessuto Brera D33
 - N°4 cuscini Alison H. 500 x L. 500 mm rivestiti in tessuto Brera D33
 - N°2 cuscini Alison H. 500 x L. 500 mm rivestiti in tessuto Tadao E81
 - N°1 cuscino Alison H. 400 x L. 400 mm rivestito in tessuto Tadao E81

2 Gemini tavolino tondo

Finitura essenza Ebano lucido L62. Dimensioni: Ø 1000 x H. 242 mm

3 Stiletto tavolino

Finitura piano in marmo Calacatta Oro CA, finitura basamento: stelo metallo verniciato Gesso opaco 001 e base metallo verniciato Ottone Anticato 537
Dimensioni: Ø 800 x H. 323 mm

4 Virgin poltrona senza braccioli

Rivestimento in tessuto Tadao E81, base in metallo verniciato Nero 538
Dimensioni: L. 670 x P. 730 x H. 700 mm

5 Milvian madia alta bifacciale

Finitura top in marmo Calacatta Oro CA, spalle sagomate in alluminio verniciato Bronzo 528, frontali in essenza Olmo Grey 53, struttura interna laccata lucida Marsala L94.
Dimensioni: L. 1030 x P. 516 x H. 1100 mm

6 Moai tavolino

Finitura laccato lucido Petrolio L9H. Dimensioni: Ø 350 x H. 460 mm

1 Argo sofa

- Composed of:
- Left 30° corner L. 2493 x D. 1588 x H. 770 mm - armrest L. 300 mm - full seat cushion, upholstered in Brera D33 fabric
 - Pouf W. 1470 x D. 970 x H. 390 mm - W. 300 x D. 490 H. 160 mm upholstered in Brera D33 fabric and glossy Ebony veneer L62
 - Right terminal element W. 2240 x D. 970 x H. 770 mm - W. 300 x D. 840 x H. 160 mm - full seat cushion, upholstered in Brera fabric D33 and finish top in glossy Ebony wood L62
 - Chaise longue 45° inclined W. 1756 x D. 1706 x H. 770 mm - full seat cushion, upholstered in Brera D33 fabric
 - N° 4 Alison cushions H. 500 x L. 500 mm upholstered in Brera D33 fabric
 - N° 2 Alison cushions H. 500 x L. 500 mm upholstered in Tadao E81 fabric
 - N° 1 Alison cushion H. 400 x L. 400 mm upholstered in Tadao E81 fabric

2 Gemini round small table

Glossy Ebony wood L62 finish. Dimensions: Ø 1000 x H. 242 mm

3 Stiletto small table

Top in Calacatta Oro CA marble, metal base with stem painted in matt Gesso 001 and base painted in Antiqued Brass 537
Dimensions: Ø 800 x H. 323 mm

4 Virgin armchair without armrests

Upholstered in Tadao E81 fabric, base in Black painted metal 538
Dimensions: L. 670 x D. 730 x H. 700 mm

5 Milviana high double-sided sideboard

Top in Calacatta Oro CA marble, shaped aluminum sides painted Bronze 528, fronts in Olmo Grey 53 essence, internal structure in Marsala glossy lacquer L94.
Dimensions: L. 1030 x D. 516 x H. 1100 mm

6 Moai small table

Glossy lacquered Petrolio L9H finish. Dimensions: Ø 350 x H. 460 mm

Argo divano

Argo sofa

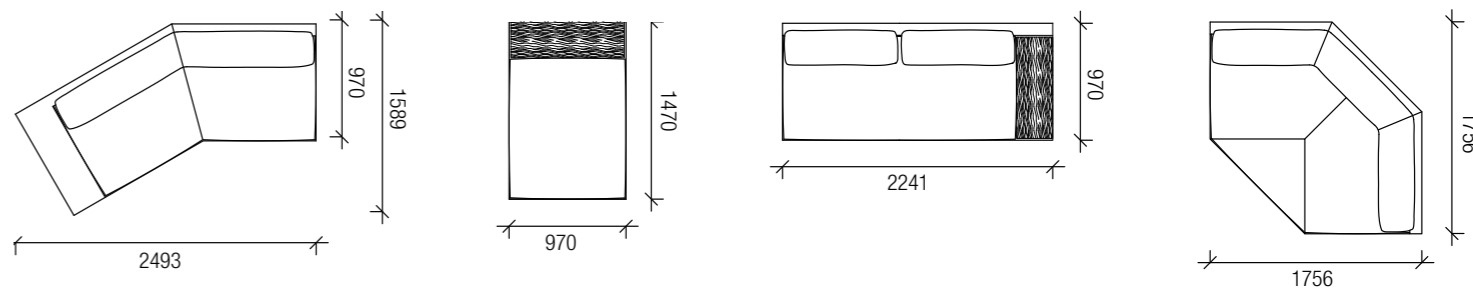

Alison cuscino

Alison cushion

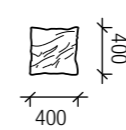
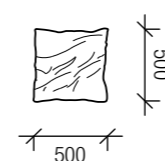

Milvian madia

Milvian sideboard

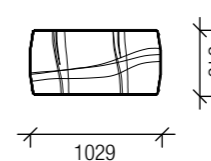

Virgin poltrona

Virgin armchair

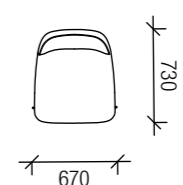

Stiletto tavolino

Stiletto small table

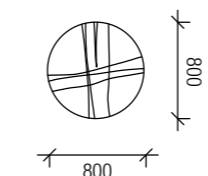

Gemini tavolino

Gemini small table

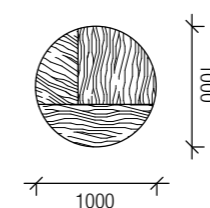

Moai tavolino

Moai small table

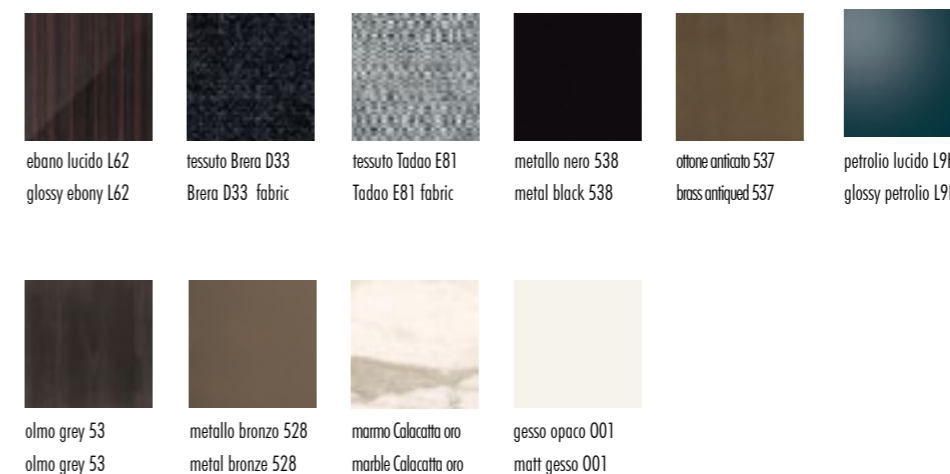
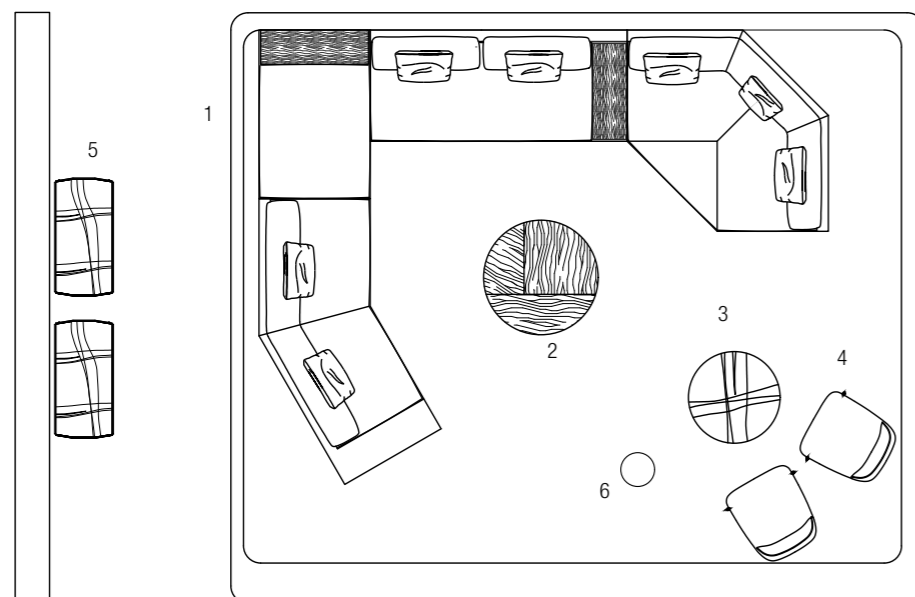
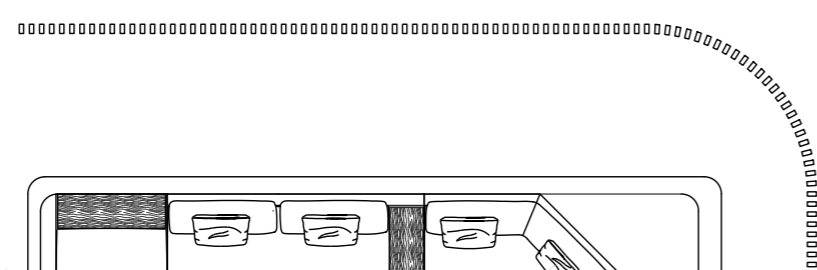
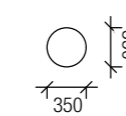



1 Over sistema giorno

Struttura essenza Tabacco 66 e laccato metallizzato Dark Bronze Anticato 537, ante e mensole in alluminio laccato metallizzato Dark Bronze Anticato 5R, attrezzato con porta bottiglie. Dimensioni: L. 3878 x P. 402 x H. 1855 mm

2 Milvian madia bassa bifacciale

Finitura top in marmo Calacatta Oro CA, spalle sagomate in alluminio verniciate Bronzo 528, frontali in essenza Ebano lucido L62, struttura interna laccata lucida Marsala L94. Dimensioni: L. 1990 x P. 516 x H. 745 mm

3 Gemini tavolino tondo

Finitura essenza Ebano lucido L62. Dimensioni: Ø 1000 x H. 242 mm

4 Divano Virgin lineare

Rivestimento in Nabuk N07, base in Metallo verniciato nero 538.

Dimensioni: L. 1650 x P. 780 x H. 720 mm

- N°1 cuscino Alison H. 500 x L. 500 mm rivestito in tessuto Gong E66

5 Virgin poltrona con braccioli

Rivestimento bi-color: retro in Pelle nera H73 e fronte in tessuto Gong E66, base in metallo verniciato Nero 538. Dimensioni: L. 700 x P. 780 x H. 700 mm

6 Stiletto tavolino

Finitura piano in marmo Marquinia MF, finitura basamento: stelo metallo verniciato Nero opaco 014 e base metallo verniciato Ottone Anticato 537. Dimensioni: Ø 450 x H. 433 mm

7 Moai tavolino

Finitura laccato lucido Marsala L94. Dimensioni: Ø 350 x H. 460 mm

8 Divano virgin round

Rivestimento in tessuto Gemma Plus D54, base in metallo verniciato Nero 538.

Dimensioni: L. 1700 x P. 935 x H. 720 mm

- N°1 cuscino Alison H. 500 x L. 500 mm rivestito in tessuto Tadao E81

9 Virgin poltrona senza braccioli

Rivestimento in tessuto Tadao E81, base in metallo verniciato Nero 538.

Dimensioni: L. 670 x P. 730 x H. 700 mm

10 Stiletto tavolino

Finitura piano in essenza Tabacco 66, finitura basamento: stelo metallo verniciato Sepia opaco 013 e base metallo verniciato Ottone Anticato 537. Dimensioni: Ø 450 x H. 433 mm

11 Moai tavolino

Finitura laccato lucido Petrolio L9H. Dimensioni: Ø 350 x H. 460 mm

1 Over day system

Structure in Tabacco 66 wood and Antiqued Dark Bronze 537 metallic lacquer, doors and shelves in Antiqued Dark Bronze 5R metallic lacquered aluminum, equipped with bottle holders. Dimensions: L. 3878 x D. 402 x H. 1855 mm

2 Milvian low double-sided cupboard

Top in Calacatta Oro CA marble, shaped aluminum sides painted Bronze 528, fronts in glossy Ebony L62, internal structure in glossy Marsala L94 lacquer.

Dimensions: L. 1990 x D. 516 x H. 745 mm

3 Gemini round small table

Glossy Ebony wood finish L62. Dimensions: Ø 1000 x H. 242 mm

4 Virgin linear sofa

Upholstery in Nabuk N07, base metal Black painted 538.

Dimensions: L. 1650 x D. 780 x H. 720 mm

- N°1 Alison cushion H. 500 x L. 500 mm upholstery in Gong E66 fabric

5 Virgin armchair with armrests

Two-tone upholstery: back in black Leather H73 and front in Gong E66 fabric, base in metal Black painted 538. Dimensions: L. 700 x D. 780 x H. 700 mm

6 Stiletto small table

Top in Marquinia MF marble, base in Metal matt Black 014 painted stem and Antiqued Brass painted 537 metal base. Dimensions: Ø 450 x H. 433 mm

7 Moai small table

Marsala L94 glossy lacquered. Dimensions: Ø 350 x H. 460 mm

8 Virgin round sofa

Upholstery in Gemma Plus D54 fabric, base in Black painted metal 538.

Dimensions: L. 1700 x D. 935 x H. 720 mm

- N°1 Alison cushion H. 500 x L. 500 mm covered in Tadao E81 fabric

9 Virgin armchair without armrests

Upholstery in Tadao E81 fabric, base in Black painted metal 538.

Dimensions: L. 670 x D. 730 x H. 700 mm

10 Stiletto small table

Top in Tobacco 66 veneer, base in metal stem painted Sepia matt 013 and metal base Antiqued Brass painted 537. Dimensions: Ø 450 x H. 433 mm

11 Moai small table

Glossy lacquered Petrolio L9H. Dimensions: Ø 350 x H. 460 mm

Over sistema giorno

Over day system

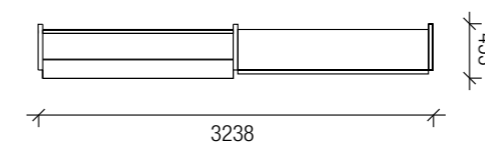

Milvian madia

Milvian sideboard

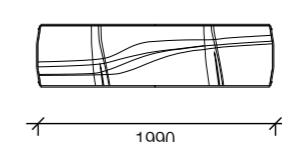

Tavolino Gemini

Gemini small table

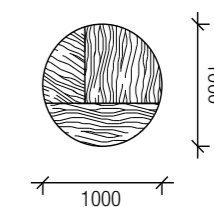

Proposta A

Divano Virgin

Virgin linear sofa

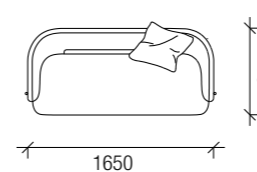

Poltrona Virgin

Virgin Armchair

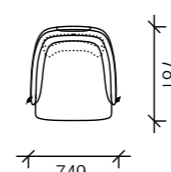

Stiletto tavolino

Stiletto small table

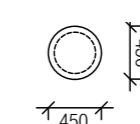

Moai tavolino

Moai small table

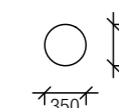

Proposta B

Divano Virgin round

Virgin round sofa

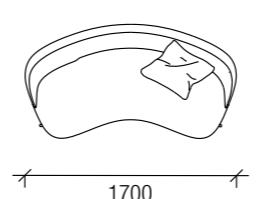

Poltrona Virgin

Virgin Armchair

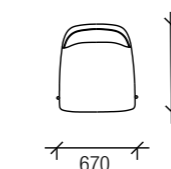

Stiletto tavolino

Stiletto small table

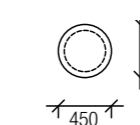

Moai tavolino

Moai small table

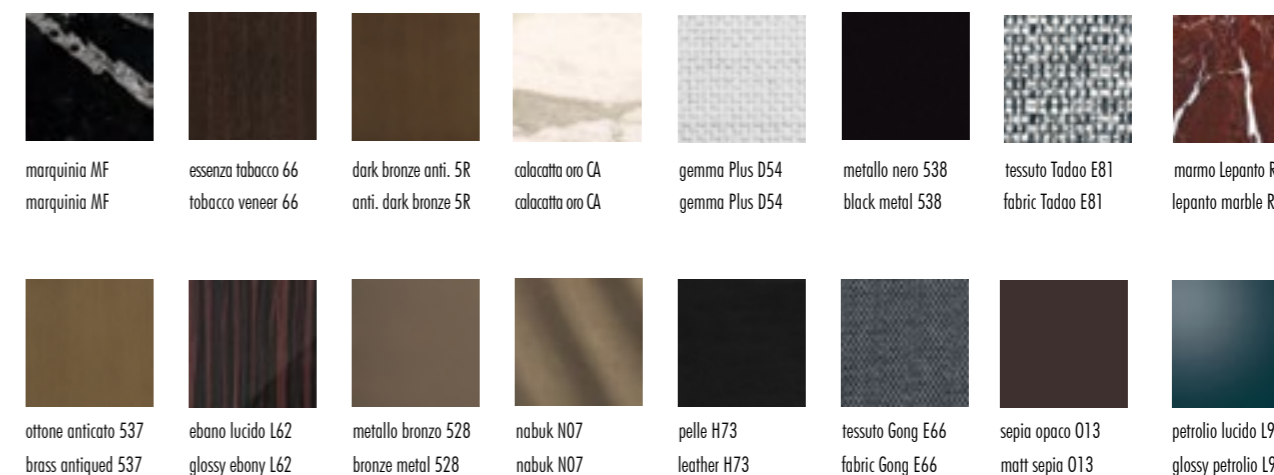
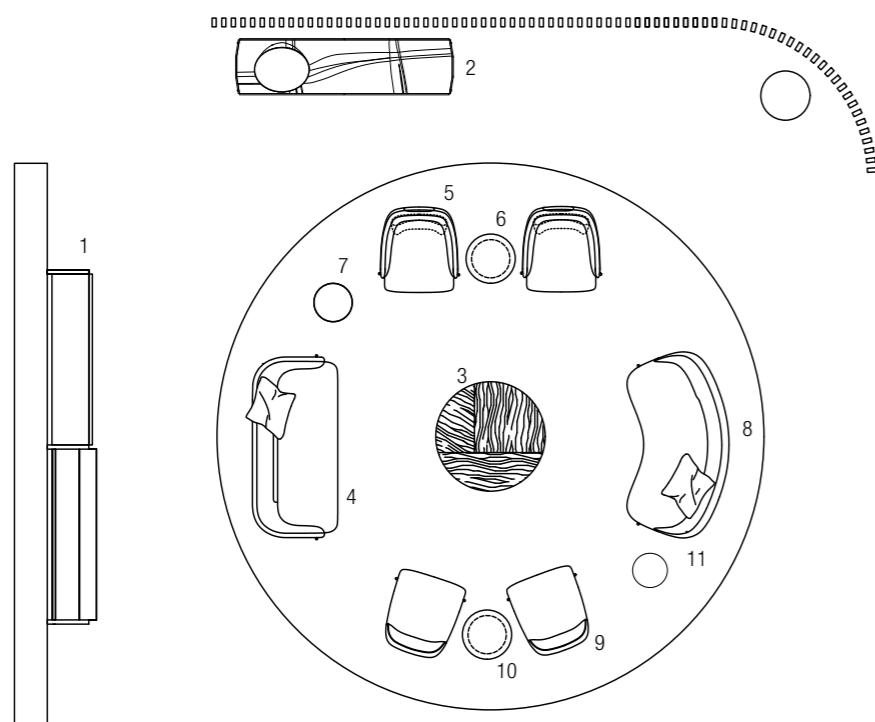
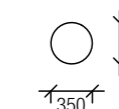



1 Crossing sistema giorno

Struttura laccato opaco Talco L02 schienali in essenza Rovere Cenere 50 e laccato lucido Ruggine L95, raster in laccato opaco Grigio lava 05B. Elemento teka in Vetro trasparente naturale V00.

Dimensioni: L. 3238 x P. 430 x H. 2895 mm

2 Kessler madia vetrina

Finitura top in laccato lucido Grigio lava L5B, ante, spalle e schienali e ripiani in Vetro fumè V05, basamento in metallo verniciato Canna di fucile 96.

Dimensioni: L. 976 x P. 517 x H. 1526 mm

3 Ala tavolo tondo

Finitura piano in marmo Sahara Noir SR, lazy susan e basamento in finitura laccato metallizzato Graphite Anticato 6R. Dimensioni: Ø 2400 h 763 mm

4 Virgin sedia senza braccioli (N°3)

Rivestimento in tessuto Funky C77, base in metallo verniciato Nero 538.

Dimensioni: L. 550 x P. 570 x H. 830 mm

5 Virgin sedia con braccioli (N°3)

Rivestimento bi-color: retro in Pelle nera H73 e fronte in tessuto Gong E66, base in metallo verniciato Nero 538.

Dimensioni: L. 590 x P. 640 x H. 800 mm

1 Crossing day system

Structure in matt Talco lacquer L02, backpanels in Oak Cenere 50 and glossy Ruggine lacquer L95, raster in matt Grigio Lava 05B lacquer. Teka element in natural transparent Glass V00.

Dimensions: L. 3238 x D. 430 x H. 2895 mm

2 Kessler sideboard showcase

Top in glossy lacquered Grigio Lava L5B, doors, sides, backs and shelves in V05 smoked Glass, base in metal Gunmetal painted 96.

Dimensions: L. 976 x D. 517 x H. 1526 mm

3 Ala round table

Top in Sahara Noir SR marble, lazy susan and base in Antiqued Graphite 6R metallic lacquered finish.

Dimensions: Ø 2400 h 763 mm

4 Virgin chair without armrests (N° 3)

Upholstery in Funky C77 fabric, base in Black painted metal 538.

Dimensions: L. 550 x D. 570 x H. 830 mm

5 Virgin chair with armrests (N° 3)

Two-tone upholstery: back in black Leather H73 and front in Gong E66 fabric, base in Black painted metal 538.

Dimensions: L. 590 x D. 640 x H. 800 mm

Kessler madia

Kessler sideboard

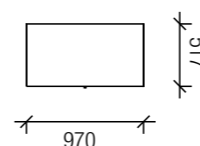

Crossing sistema giorno

Crossing system



Tavolino Gemini

Gemini small table

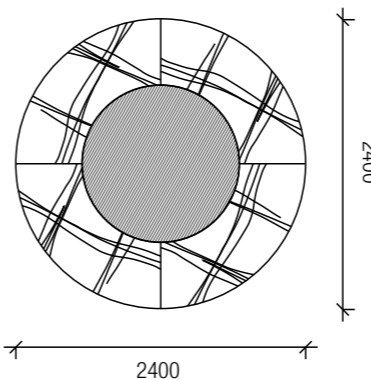

Sedia Virgin

Virgin chair without armrest

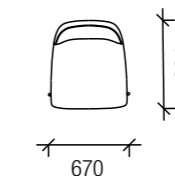

Sedia Virgin

Virgin chair with armrest

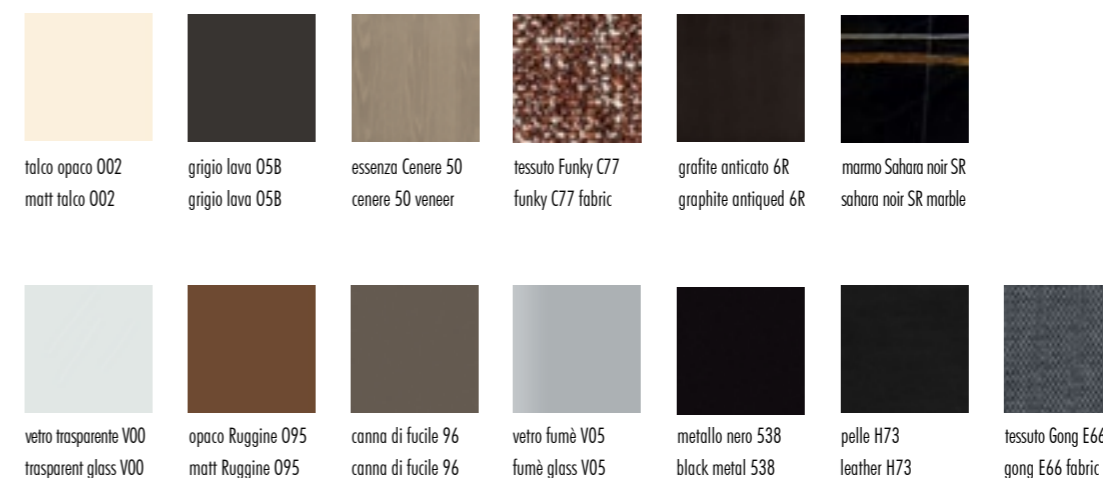
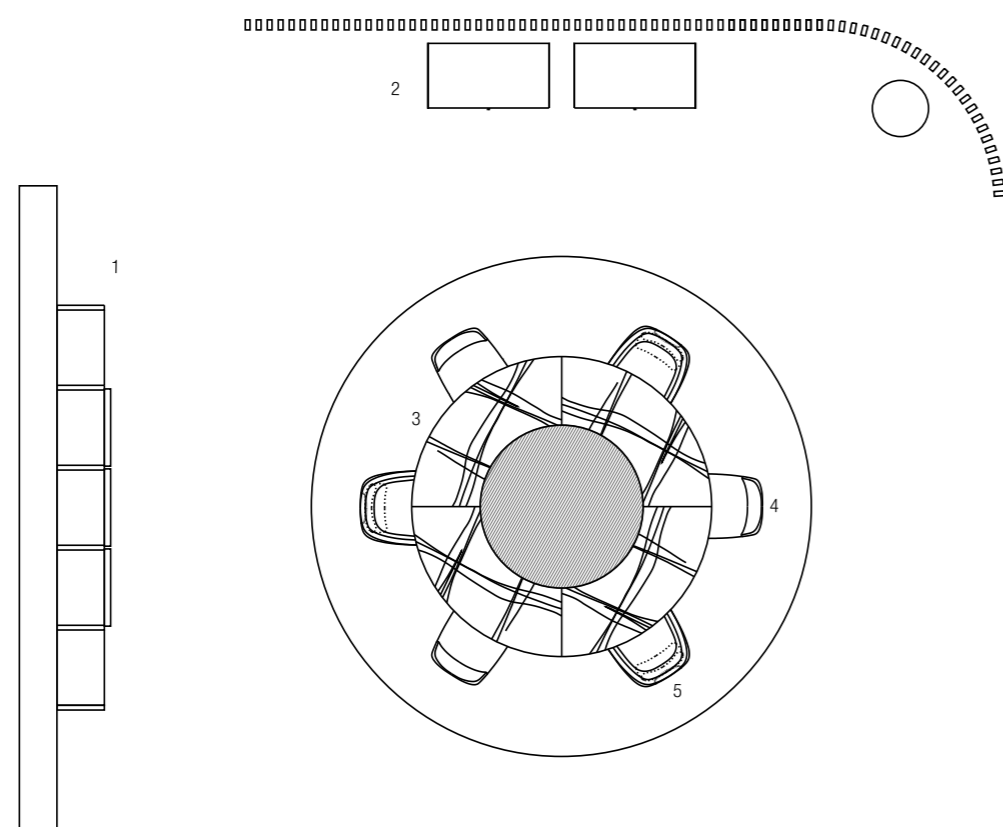
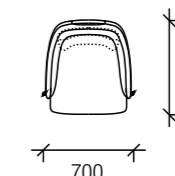



1 Palo Alto Wall

Sistema notte con schienale in essenza Millerighe Eucalipto, ripiani frame in vetro Trasparente Fumè V05, cassettera sospesa Nobilitato Shantung di seta 879, tubi appendiabito, maniglie Cardea e top cassettiere in ecopelle lavorata CL1 Sabbia.
 Dimensioni: L. 5555 x P. 695 x H. 3500

2 Composizione Puzzle integrata a Palo Alto I-Box

Pannelli sistema Boserie Puzzle in finitura melaminico Cementino White, ante Puzzle Palo Alto I-Box, in finitura melaminico Cementino White.
 Dimensioni: L. 3208 x P. 1424 H. 3500

3 Divano Virgin round

Rivestimento in pelle nabuccata HN2 Rinoceronte.
 Dimensioni: L. 1700 x P. 935 H. 720

4 Virgin poltrona con braccioli

Rivestimento in tessuto Jojo B44 Lichene.
 Dimensioni: L. 700 x P. 780 x H. 720

5 Pouf Stone

Rivestimento in Nabuk trapunato N10 Tigre.
 Dimensioni: L. 1050 x P. 1050 x H 400

6 Stiletto tavolino

Finitura piano in marmo Calacatta Oro CA, stelo laccato opaco Gesso 01, base in Dark Bronze Anticato 5R.
 Dimensioni: Ø 800 x H 323

7 Rialto tavolino

Finitura piano in vetro Trasparente Fumè V05, base in metallo verniciato Nero e Ottone Anticato 537.
 Dimensioni: Ø 700 x H 420

1 Palo Alto Wall

Night system with back in Eucalyptus Millerighe, shelves in Transparent Fumè V05 glass, suspended chest of drawers in Silk Shantung 879 Melamine, rails clothes, Cardea handles and top cassettiere in CL1 Sand embossed eco-leather.
 Dimensions: L. 5555 x D. 695 x H. 3500

2 Integrated Puzzle composition in Palo Alto I-Box

Puzzle boiserie system panels in Cementino White melamine, Puzzle Doors Palo Alto I-Box in Cementino White melamine.
 Dimensions: L. 3208 x D. 1424 H. 3500

3 Virgin roud sofa

Upholstery in nabuk leather HN2 Rinoceronte.
 Dimensions: L. 1700 x D. 935 H. 720

4 Virgin armchair with armrest

Upholstery in fabric Jojo B44 Lichene.
 Dimensions: L. 700 x D. 780 x H. 720

5 Stone pouf

Upholstery in quilted Nabuk N10 Tigre.
 Dimensions: L. 1050 x D. 1050 x H 400

6 Stiletto small table

Top in Calacatta Oro CA marble, stem in Gesso 01 matt lacquered, base in Antique Dark Bronze 5R.
 Dimensions: Ø 800 x H 323

7 Rialto small table

Top in Fumè Transparent glass V05, base in Black 538 varnished metal and Antique Brass painted metal 537.
 Dimensions: Ø 700 x H 420

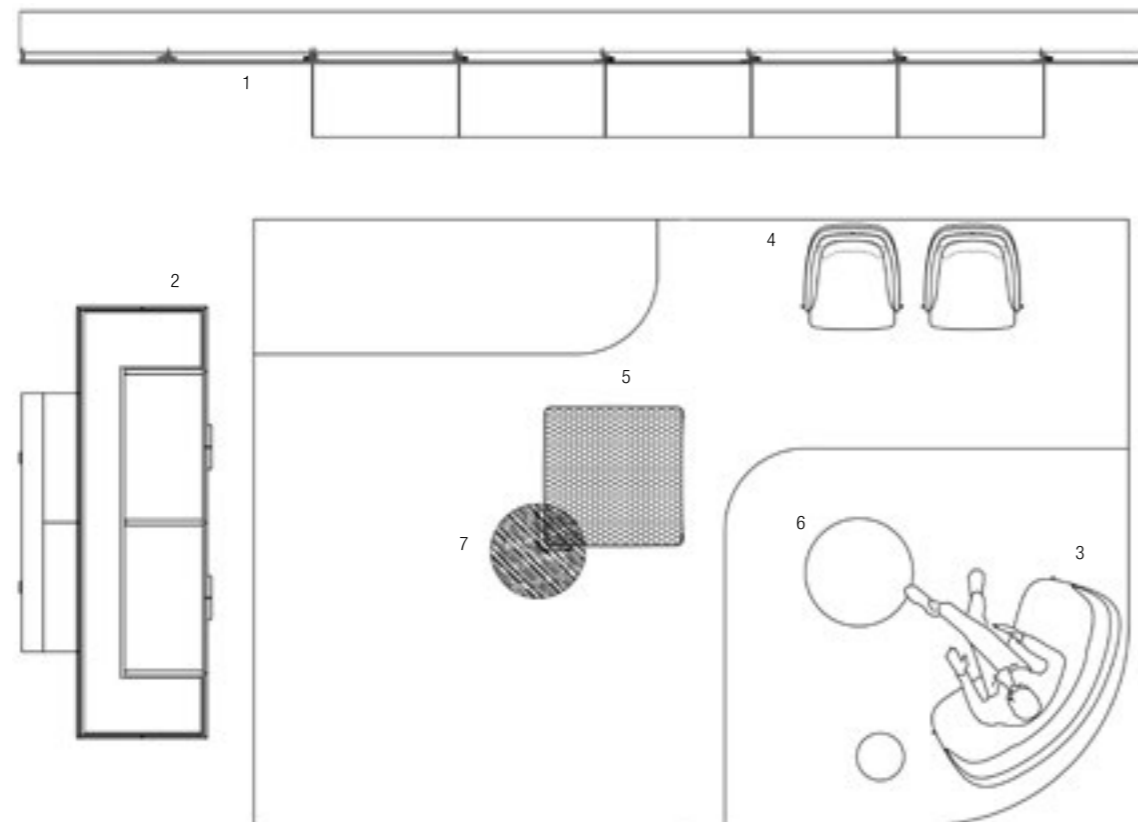

Palo Alto Wall

Palo Alto Wall

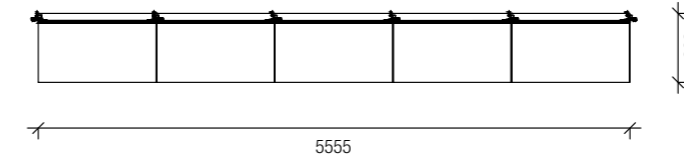

Composizione Puzzle integrata a Palo Alto I-Box
Integrated Puzzle composition in Palo Alto I-Box

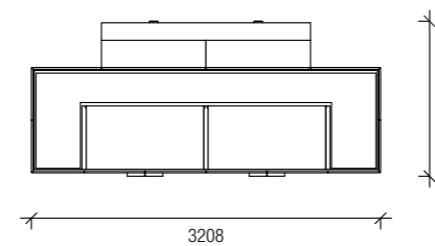

Divano Virgin round
Virgin round sofa

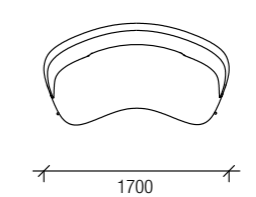

Poltrona Virgin
Virgin armchair

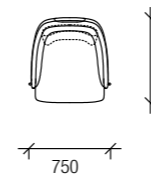

Pouf Stone
Stone pouf

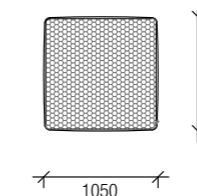

Tavolino Stiletto
Stiletto small table

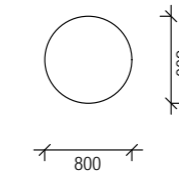

Tavolino Rialto
Rialto small table

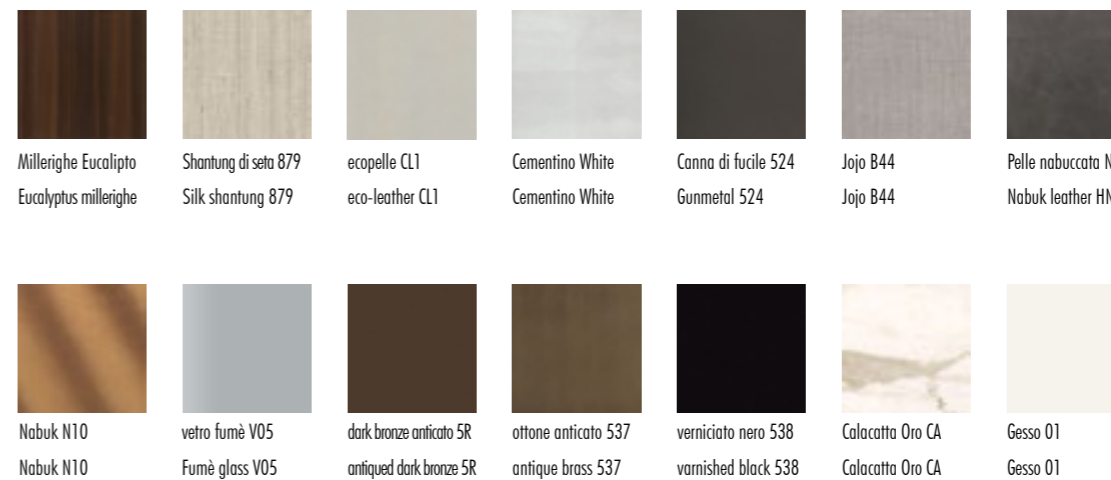
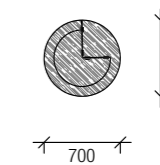



1 Virgin letto

Rivestimento in tessuto Indianskop D1C.
Dimensioni: L. 2000 x P. 2238 x H. 913 mm

2 Palo Alto Free cabina armadio

Struttura in metallo verniciato Canna di fucile 524, ripiani frame Vetro trasparente naturale V00, cassettiere sospese in nobilitato Olmo Tranchè 878 e top in ecopelle CM9, anta Rex in Vetro fumè V05.
Dimensioni: L. 3388 x P. 627 x H. 2820 mm

3 Eros comodino (N°2)

Finitura piano in marmo Calacatta Oro CA, struttura in essenza Rovere Nero 51 e basamento in metallo verniciato Bronzo 528.
Dimensioni: L. 700 x P. 410 x H. 486 mm

4 Eros comò

Finitura piano in marmo Marquinia MF, struttura in essenza Rovere Nero 51 e basamento in metallo verniciato Bronzo 528.
Dimensioni: L. 1280 x P. 535 x H. 773 mm

5 Virgin round divano

Rivestimento in Nabuk N09, base in metallo verniciato Nero 538.
Dimensioni: L. 1700 x P. 935 x H. 720 mm

6 Virgin pouf

Rivestimento in Nabuk N09, base in metallo verniciato Nero 538.
Dimensioni: L. 650 x P. 530 x H. 400 mm

1 Virgin bed

Upholstery in Indianskop D1C fabric.
Dimensions: L. 2000 x P. 2238 x H. 913 mm

2 Palo Alto Free walk-in closet

Metal structure in Gunmetal 524 painted, V00 natural transparent Glass frame shelves, suspended drawer units in Tranchè Elm melamine 878 and top finish in eco-leather CM9, Rex door in smoked Glass V05.
Dimensions: L. 3388 x P. 627 mm.

3 Eros bedside table (N° 2)

Top finish in Calacatta Oro CA marble, structure in Black Oak 51 veneer and base in metal Bronze 528 painted.
Dimensions: L. 700 x D. 410 x H. 486 mm

4 Eros chest of drawers

Top in Marquinia MF marble, structure in Black Oak 51 veneer and base metal Bronze 528 painted.
Dimensions: L. 1280 x D. 535 x H. 773 mm

5 Virgin round sofa

Upholstery in Nabuk N09, base in metal Black 538 painted.
Dimensions: L. 1700 x D. 935 x H. 720 mm

6 Virgin pouf

Upholstery in Nabuk N09, base in metal Black 538 painted.
Dimensions: L. 650 x D. 530 x H. 400 mm

**Virgin letto
Virgin bed**

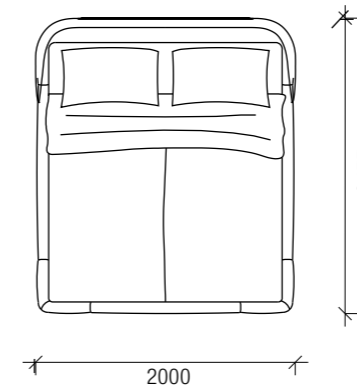

**Palo Alto Free cabina armadio
Palo Alto Free walk in closet**

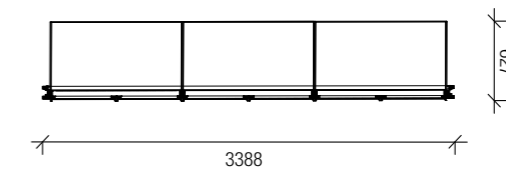

**Virgin round divano
Virgin round sofa**

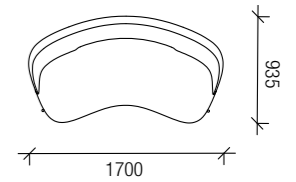

Eros comò

Eros chest of drawers

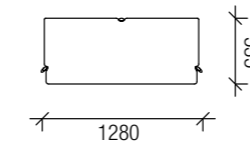

Eros comodino

Eros bedside table

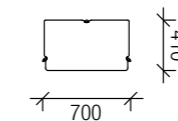

Virgin pouf

Virgin pouf

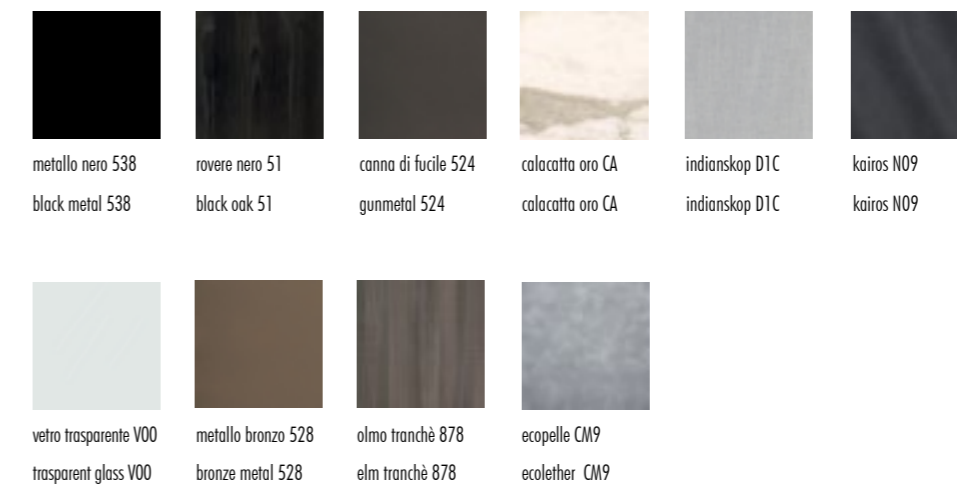
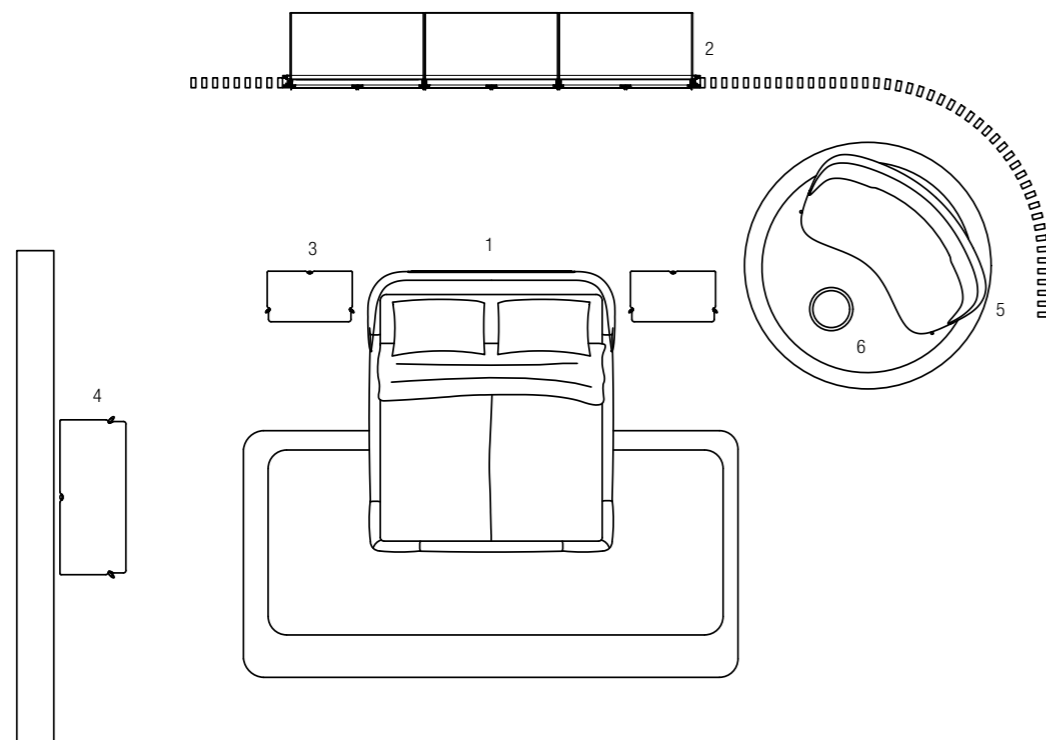
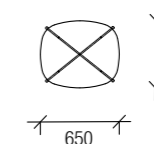

BOISERIE PUZZLE.

Puzzle, sistema boiserie in legno, legno dogato, vetro e melaminico, esprime il fascino senza tempo e il calore di un materiale nobile e naturale capace di avvolgere tutte le stanze della casa creando un'atmosfera al tempo stesso accogliente ed elegante. **Puzzle** rappresenta una boiserie esclusiva, funzionale e sofisticata, con l'eleganza dello stile inconfondibile MisuraEmme espresso in ogni dettaglio, anche costruttivo, la rigorosa geometria delle rette parallele e perpendicolari, scandiscono e sottolineano una struttura moderna e diventano parte integrante dell'architettura. Questo progetto completamente customizzabile sia in altezza che in larghezza, che si può sviluppare sia in verticale che in orizzontale, apre un ventaglio infinito di possibilità d'arredo e permette di creare un ammaliante dialogo fra materiali di qualità impareggiabile, fornendo al progettista diverse opportunità progettuali.

Puzzle, a wood paneling system, slatted wood, glass and melamine, expresses the timeless charm and warmth of a noble and natural material capable of enveloping all the rooms of the house, creating an atmosphere that is both welcoming and elegant. **Puzzle** represents an exclusive, functional and sophisticated woodland, with the elegance of the unmistakable MisuraEmme style expressed in every detail, including construction, the rigorous geometry of the parallel and perpendicular lines, mark and emphasize a modern structure and become an integral part of the architecture. This completely customizable project both in height and in width, which can be developed both vertically and horizontally, opens up an infinite range of furnishing possibilities and allows you to create a bewitching dialogue between materials of unparalleled quality, providing the designer with various design opportunities.

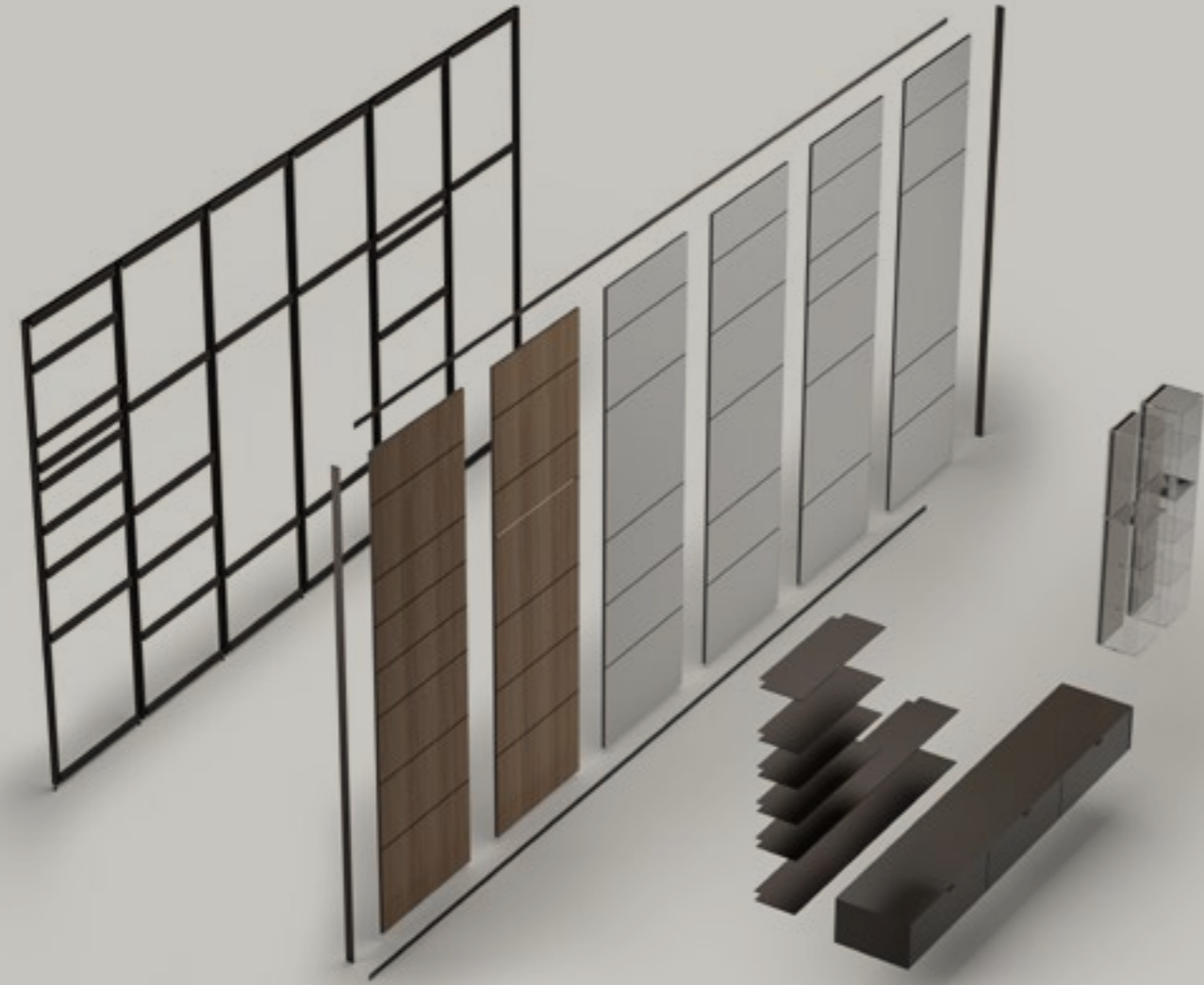

Puzzle è un sistema Boiserie costituito da un sistema di intelaiatura in alluminio da fissare a muro e da una serie di ante telaio, che si agganciano alla struttura in alluminio a muro frontalmente. Tali ante a telaio possono svilupparsi verticalmente o orizzontalmente e possono essere utilizzate in entrambi i casi nella stessa composizione. E' caratterizzato da profili con fuga da 6 mm in alluminio verniciato sia verticali che orizzontali, che ne caratterizzano il design. I profili orizzontali là dove previsto, hanno anche la funzione di attacco per i vari elementi da integrare alla boiserie. E' possibile inserire nei telai diverse finiture; Essenza, essenze dogate, vetri, ceramiche, melaminici. I perimetri sono definiti con profili di finitura o fasce di tamponamento, laterali, superiori ed inferiori. Le fasce di tamponamento superiori ed inferiori possono essere dotate di LED orizzontali.

Puzzle is a Boiserie system consisting of an aluminum frame system to be fixed to the wall and a series of frame doors, which hook onto the aluminum wall structure from the front. These framed doors can develop vertically or horizontally and can be used in both cases in the same composition. It features both vertical and horizontal profiles with 6 mm joint in painted aluminum, which characterize its design. Where required, the horizontal profiles also have the function of attachment for the various elements to be integrated into the boiserie. It is possible to insert different finishes in the frames; Wood, staved wood, glass, ceramic, melamine. The perimeters are defined with finishing profiles or infill bands, lateral, upper and lower. The upper and lower buffer strips can be equipped with horizontal LED.



Le immagini soprariportate mostrano un esploso di una composizione di **Puzzle**. Da sinistra verso destra, si possono notare: I montanti e i traversi da fissare a muro a formare un'intelaiatura in alluminio, i telai con i relativi traversi che vengono fissati all'intelaiatura in alluminio a muro e infine gli elementi integrabili: Contenitori, teke e mensole sp 6mm.

The above images show an exploded view of a **Puzzle** composition. From left to right, you can see: The uprights and crosspieces to be fixed to the wall to form an aluminum frame, the frames with the relative crosspieces that are fixed to the aluminum wall frame and finally the integrable elements: Containers, teke and 6mm thick shelves.

PALO ALTO WALL.

Palo Alto Wall, sistema notte a boiserie in legno vetro e melaminico, esprime il fascino senza tempo e il calore di un materiale nobile e naturale capace di avvolgere la camera da letto, la zona più intima e personale della casa, in un'atmosfera al tempo stesso accogliente ed elegante. **Palo Alto Wall** rappresenta l'elemento distintivo di una zona notte esclusiva, funzionale e sofisticata, con l'eleganza dello stile inconfondibile MisuraEmme espresso in ogni dettaglio, anche costruttivo, supera il limite dell'essere un semplice prodotto a cremagliera e diventa un rivestimento murale terra soffitto, con la possibilità di integrare tutta l'attrezzatura dedicata alla zona notte, già compatibile coi sistemi **Palo Alto Free** e **Palo Alto I-Box**.

Palo Alto Wall, a night system with wood, glass and melamine boiserie, expresses the timeless charm and warmth of a noble and natural material capable of enveloping the bedroom, the most intimate and personal area of the house, in an atmosphere of at the same time welcoming and elegant. **Palo Alto Wall** represents the distinctive element of an exclusive, functional and sophisticated sleeping area, with the elegance of the unmistakable MisuraEmme style expressed in every detail, even constructive, overcomes the limit of being a simple rack product and becomes a wall covering floor-to-ceiling, with the possibility of integrating all the equipment dedicated to the sleeping area, already compatible with the **Palo Alto Free** and **Palo Alto I-Box** systems.

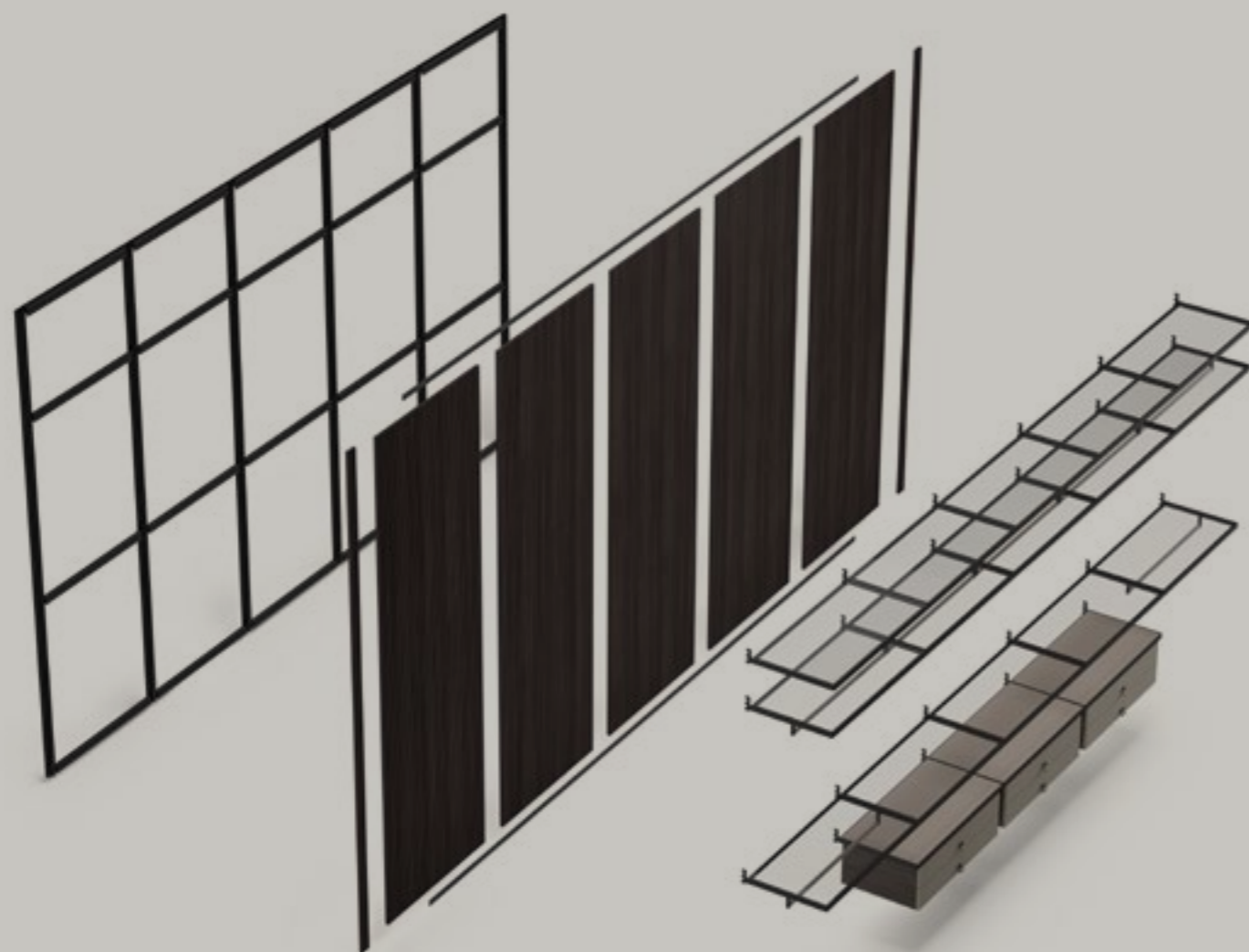

Palo Alto Wall, è costituito da un'intelaiatura a muro, scandita da montanti elettrificati, ai quali vengono poi agganciati frontalmente pannelli di diversa finitura: Legno, vetro e melaminico. Completamente customizzabile in altezza e larghezza, grazie alla grande quantità di moduli di serie, è possibile attrezzare **Palo Alto Wall** con l'attrezzatura già disponibile per i sistemi **Palo Alto I-Box** e **Palo Alto Free**. Tale attrezzatura è fissata alle cremagliere attraverso staffe regolabili verticalmente in altezza. E' possibile finire il perimetro del prodotto, con profili di finitura o fasce di tamponamento, laterali, superiori ed inferiori. Le fasce di tamponamento superiori ed inferiori possono essere dotate di LED orizzontali.

Palo Alto Wall, consists of a wall frame, marked by electrified uprights, to which panels of different finishes are then hooked from the front: Wood, glass and melamine. Completely customizable in height and width, thanks to the large amount of standard modules, it is possible to equip **Palo Alto Wall** with the equipment already available for the **Palo Alto I-Box** and **Palo Alto Free** systems. This equipment is fixed to the racks by means of vertically adjustable brackets. It is possible to finish the perimeter of the product, with finishing profiles or infill bands, lateral, upper and lower. The upper and lower buffer strips can be equipped with horizontal LED.



Le immagini soprariportate mostrano un esplosione di una composizione di **Palo Alto Wall**. Da sinistra verso destra, si possono notare: I montanti e i traversi da fissare a muro a formare un'intelaiatura in alluminio, i pannelli che vengono fissati all'intelaiatura in alluminio a muro, e infine l'attrezzatura completamente compatibile con gli altri sistemi notte **Palo Alto I-Box** e **Palo Alto Free**.

The above images show an exploded view of a composition by **Palo Alto Wall**. From left to right, you can see: The uprights and crosspieces to be fixed to the wall to form an aluminum frame, the panels that are fixed to the aluminum wall frame, and finally the equipment completely compatible with the other night systems **Palo Alto I-Box** and **Palo Alto Free**.

PALO ALTO FREE.

Evoluzione di Palo Alto I Box, Palo Alto Free è il nuovo concetto di cabina armadio che vede l'utilizzo dell'anta direttamente sorretta dal palo terra-soffitto anteriore che ne costituisce la struttura, a formare un sistema di porte attrezzate che hanno anche la funzione di coprire le nicchie e lasciare una straordinaria libertà compositiva, grazie alla possibilità di progettare composizioni completamente su misura in altezza ed in larghezza.

Evolution of Palo Alto I Box, Palo Alto Free is the new concept of walk-in closet. This sees the use of the door directly supported by the front ground-ceiling pole which constitutes the structure. It forms a system of equipped doors which also have the function of covering completely the niches, thanks to the possibility of designing compositions that are completely made to measure in height and width.



Vista frontale di composizione **Palo Alto Free**, con 4 ante **Rex** battenti in Vetro laterali e 2 ante **Rex** in vetro centrali, con sistema di apertura RX6. In questa soluzione l'utilizzo dell'anta **Rex** con sistema apertura RX6, con la possibilità di ottenere un'apertura totale del vano centrale del sistema notte, per una maggiore comodità ed accessibilità.

Front view of **Palo Alto Free** composition, with 4 **Rex** side hinged doors in glass and 2 central **Rex** doors in glass, with RX6 opening system. In this solution, the use of the **Rex** door with RX6 opening system, allows the possibility to get a total opening of the central compartment of the night system, for greater comfort and accessibility.



Vista frontale di composizione **Palo Alto Free**, con 4 ante **Rex** in vetro centrali, con sistema di apertura RX6. In questa soluzione viene mostrato come l'anta **Rex** col sistema di apertura RX6, può essere utilizzato su tutti i vani del sistema notte. Tuttavia è necessario non avere impedimenti laterali, per poter aprire le ante laterali.

Front view of **Palo Alto Free** composition, with 4 central glass doors **Rex**, with RX6 opening system. In this solution it is shown how the **Rex** door with the RX6 opening system, can be used on all the compartments of the night system. However, it is necessary not to have lateral impediments, in order to open the side doors.



Vista frontale di composizione **Palo Alto Free**, con 4 ante **Rex** battenti in Vetro laterali e 2 ante **Rex** in vetro centrali, con sistema di apertura **RX6**. In questa soluzione viene mostrato l'utilizzo dell'anta **Rex** con sistema apertura **RX6**, come porta per accesso ad una stanza/cabina armadio. E' possibile ottenere un'apertura massima di 2164mm.

Front view of **Palo Alto Free** composition, with 4 **Rex** hinged doors in glass and 2 central **Rex** doors in glass, with **RX6** opening system. This solution shows the use of the **Rex** door with **RX6** opening system, as a door for access to a room / walk-in closet. It is possible to obtain a maximum opening of 2164mm.



Vista frontale di composizione **Palo Alto Free**, con 4 ante **Tecno** in finitura nobilitato metallizzato Champagne, 2 ante **Rex** battenti in Vetro laterali e 1 anta **Rex** in vetro centrali, con sistema di apertura **RX6**. In questa soluzione viene evidenziato come è possibile ottenere un passaggio porta agevole grazie al nuovo sistema di apertura **RX6**, montato sull'anta **Rex**, inoltre viene mostrato come sia possibile installare anche ante diverse sul sistema notte **Palo Alto Free**.

Front view of **Palo Alto Free** composition, with 4 **Tecno** doors in melamine metallic champagne finish, 2 side **Rex** hinged doors in glass and 1 central **Rex** door in glass, with **RX6** opening system. In this solution it is highlighted how it is possible to obtain an easy door passage thanks to the new **RX6** opening system, mounted on the **Rex** door, it is also shown how it is also possible to use different doors on the **Palo Alto Free** night system.



Vista frontale obliqua di composizione **Palo Alto Free**, con 4 ante **Tecno** in finitura nobilitato metallizzato Champagne, 2 ante **Rex** battenti in Vetro laterali e 1 anta **Rex** in vetro centrali, con sistema di apertura RX6. In questa soluzione viene evidenziato come è possibile ottenere un passaggio porta agevole grazie al nuovo sistema di apertura RX6, montato sull'anta **Rex**, inoltre viene mostrato come sia possibile installare anche ante diverse sul sistema notte **Palo Alto Free**.

Oblique front view of **Palo Alto Free** composition, with 4 **Tecno** doors in melamine metallic champagne finish, 2 **Rex** side hinged doors in glass and 1 central **Rex** door in glass, with RX6 opening system. In this solution it is highlighted how it is possible to obtain an easy door passage thanks to the new RX6 opening system, mounted on the **Rex** door. Furthermore, it is also shown how it is also possible to fit different doors on the **Palo Alto Free** night system.



Vista posteriore obliqua di composizione **Palo Alto Free**, con 4 ante **Tecno** in finitura nobilitato metallizzato Champagne, 2 ante **Rex** battenti in Vetro laterali e 1 anta **Rex** in vetro centrali, con sistema di apertura RX6. In questa soluzione viene evidenziato come è possibile ottenere un passaggio porta agevole grazie al nuovo sistema di apertura RX6, montato sull'anta **Rex**, inoltre viene mostrato come sia possibile installare anche ante diverse sul sistema notte **Palo Alto Free**.

Oblique rear view of **Palo Alto Free** composition, with 4 **Tecno** doors finish in melamine metallic champagne, 2 **Rex** side hinged doors in glass and 1 **Rex** central door in glass, with RX6 opening system. In this solution it is highlighted how it is possible to obtain an easy door passage thanks to the new RX6 opening system, mounted on the **Rex** door. In addition it is also shown how it is possible to fit different doors on the **Palo Alto Free** night system.

Concept, art direction
MisuraEmme® studio

Photography
Michele Poli Mascheroni

Render
Virtual Design

Styling
Studio Rossella Battaglia
MisuraEmme® studio

Printing
Color Art Spa

Copyright
MisuraEmme®

Thanks to
ILLULIAN
ARTEMIDE
OLUCE
PENTA
NAHOOR
VENICEM
TERZANI
NEMO
DE VECCHI
GREGGIO
MEDLARS
MOTTADELLI
MAISON FIRE
IVV

All the MisuraEmme collections are
manufactured 100% in Italy
using top-class components
and materials.

Made in Italy - OIBOBA

MisuraEmme® S.p.A.
Via IV Novembre, 72
22066 Mariano Comense (CO)
Tel. +39 031.754111
Fax. +39 031.744437
info@misuraemme.it
www.misuraemme.it



The mark of
responsible forestry

Cerca prodotti certificati
FSC®



EAC

